

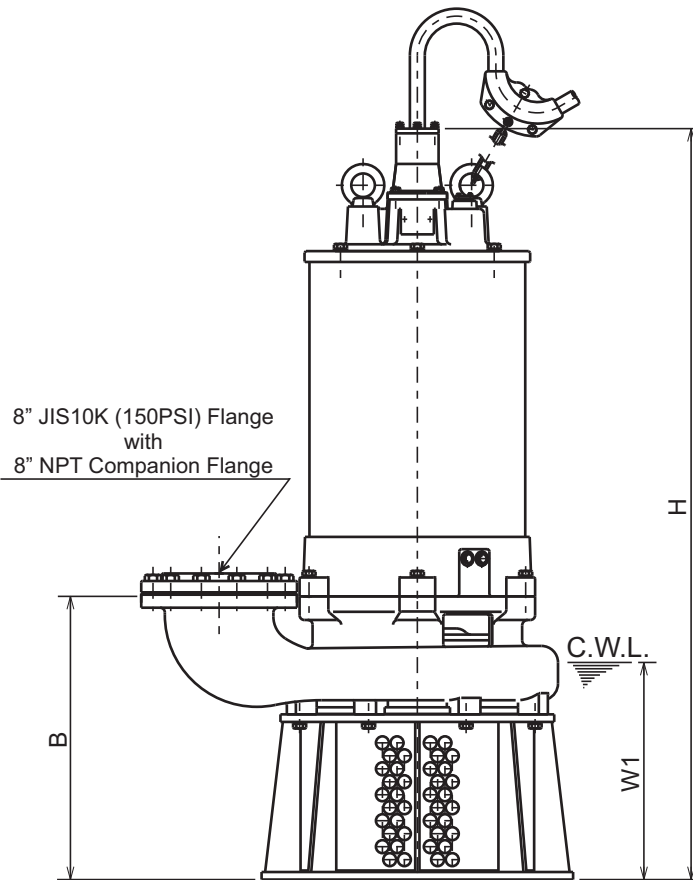

**GSZ-4 SERIES**  
HIGH VOLUME - DEWATERING PUMPS

**DIMENSIONS**

**GSZ4-45-4**

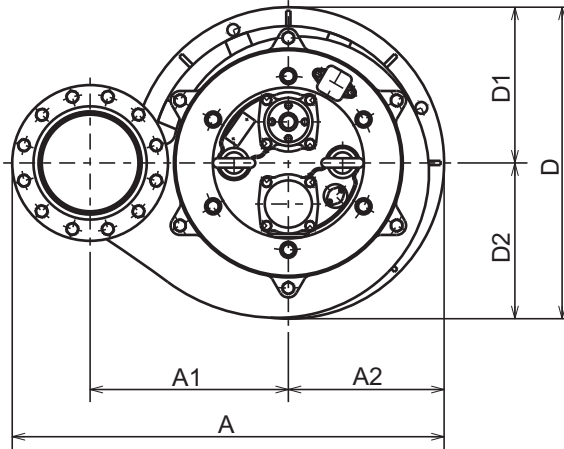

C.W.L. : Continuous running Water Level

**DIMENSIONS:USCS (Inch)**

Model	HP	NOM. SIZE	Pump & Motor								C.W.L.	*Wt.
			A	A1	A2	B	D	D1	D2	H	W1	(lbs.)
GSZ4-45-4	60	8"	36	16 9/16	13	23 5/8	26	13	13	62 5/8	18 1/8	1300

\*Excluding Cable

**DIMENSIONS:METRIC (mm)**

Model	kW	NOM. SIZE	Pump & Motor								C.W.L.	*Wt.
			A	A1	A2	B	D	D1	D2	H	W1	(kg)
GSZ4-45-4	45	200	915	420	330	600	660	330	330	1591	460	590