

TO200BK437 -63

Guide Rail System : TO-200
Weight : 198lbs. (90kg)

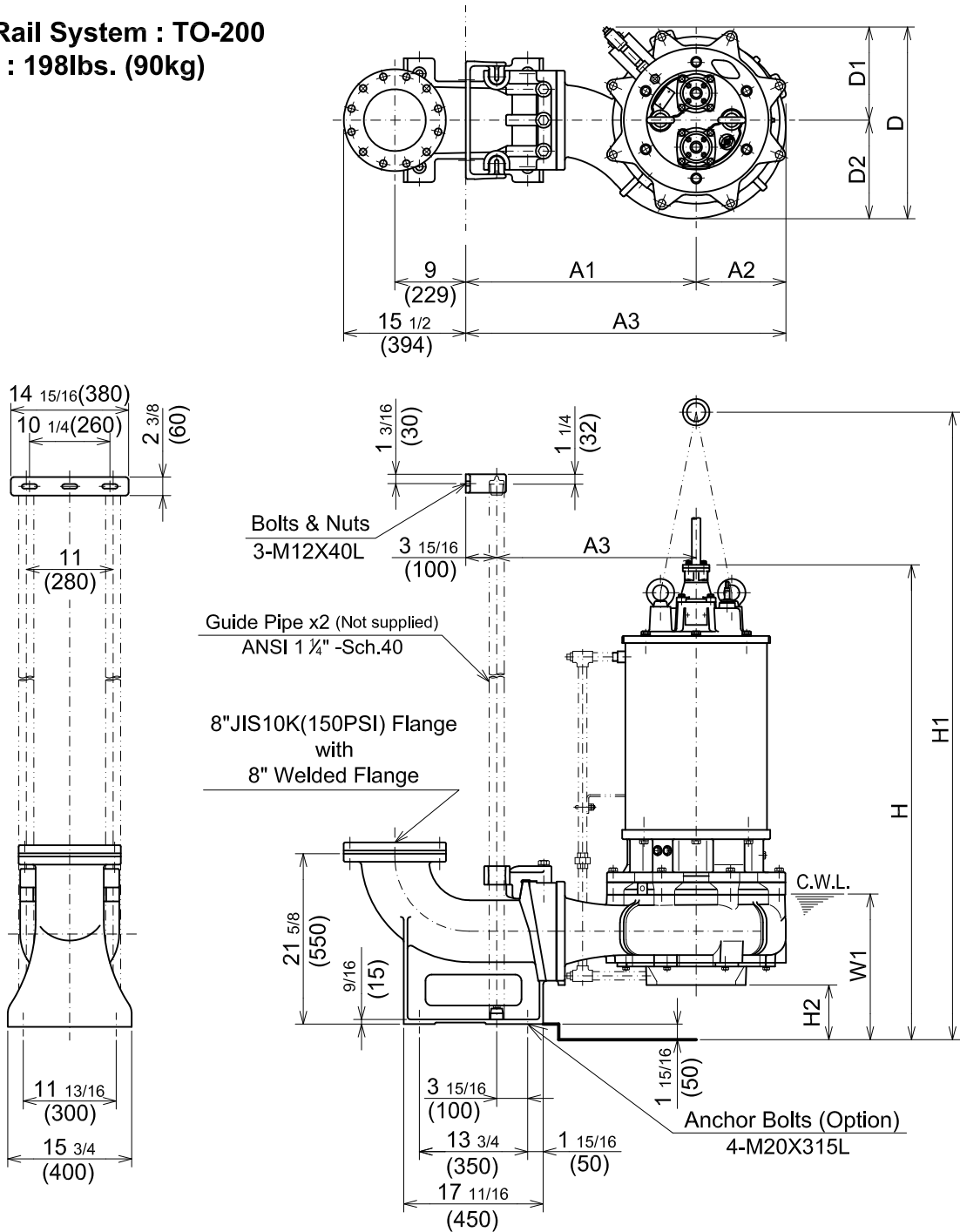

C.W.L. :Continuous running Water Level

DIMENSIONS:USCS (Inch)

Model	HP	NOM. SIZE	Pump & Motor										C.W.L. W1	*Wt. (lbs.)
			A	A1	A2	A3	D	D1	D2	H	H1	H2		
TO200BK437-63	50	8"	40 11/16	29 5/16	11 7/16	25 3/8	24 3/8	11 7/8	12 1/2	60 1/8	79 1/2	6 15/16	18 1/2	1660

DIMENSIONS:METRIC (mm)

Model	kW	NOM. SIZE	Pump & Motor										C.W.L. W1	*Wt. (kg)
			A	A1	A2	A3	D	D1	D2	H	H1	H2		
TO200BK437-63	37	200	1034	744	290	644	619	301	318	1527	2020	176	470	755

*Excluding TO & Cable