

# **KTV/KTVE/NK Series**

## **Submersible Dewatering Pump**

# **OPERATION MANUAL**

### **INTRODUCTION**

Thank you for selecting the Tsurumi KTV/KTVE/NK Submersible Dewatering Pump.

This operation manual provides product information as well as precautions for safe and reliable operations.

To avoid possible malfunction or an accident, acknowledge them thoroughly beforehand of pump operation.

Using the pump for applications other than those listed in this manual or failure to observe the precautions may lead to a malfunction or an accident. And in such a case, the manufacturer will not take any liability.

Therefore, keep this manual in an easily accessible place, so that the precautions/information can be referred to as needed. In addition, this operation manual should remain with the pump if rented or resold. If the operation manual gets lost or damaged, ask your nearest dealer or Tsurumi representative for another copy.

Similarly, if you cannot troubleshoot the problem(s) with the information provided in the manual or if have queries regarding the operation, service, repair, or maintenance of the submersible pump, please contact the Tsurumi pump dealer nearby your place. The contents of this document may not be copied in whole or in part without the express permission of Tsurumi Manufacturing Co., Ltd.

### **CONTENTS**

1. BE SURE TO READ FOR YOUR SAFETY .....	1
2. NAME OF PARTS .....	4
3. PRIOR TO OPERATION .....	5
4. INSTALLATION .....	6
5. ELECTRICAL WIRING .....	9
6. OPERATION.....	11
7. MAINTENANCE AND INSPECTION.....	15
8. DISASSEMBLY AND REASSEMBLY PROCEDURE.....	17
9. TROUBLESHOOTING .....	20

<b>安全須知 .....</b>	<b>i</b>
<b>為確保您的安全請務必閱讀下列資訊 .....</b>	<b>ii</b>
<b>HÃY ĐỌC KỸ ĐỂ ĐẢM BẢO AN TOÀN CHO BẠN .....</b>	<b>iii</b>
<b>กรุณาอ่านข้อความนี้เพื่อความปลอดภัยของคุณ .....</b>	<b>iv</b>
<b>PASTIKAN UNTUK MEMBACA DEMI KESELAMATAN ANDA .....</b>	<b>v</b>
<b>PASTIKAN ANDA MEMBACA UNTUK KESELAMATAN ANDA .....</b>	<b>vi</b>
<b>SIGURUHING BASAHIN PARA SA SARILING KALIGTASAN .....</b>	<b>vii</b>
<b>تأكد من القراءة من أجل سلامتك .....</b>	<b>viii</b>
<b>ASEGÚRESE DE LEER LA SIGUIENTE INFORMACIÓN PARA SU SEGURIDAD .....</b>	<b>ix</b>
<b>ASSUREZ-VOUS DE LIRE CE DOCUMENT POUR VOTRE SÉCURITÉ .....</b>	<b>x</b>
<b>ОБЯЗАТЕЛЬНО ПРОЧИТАЙТЕ ДЛЯ ВАШЕЙ СОБСТВЕННОЙ БЕЗОПАСНОСТИ .....</b>	<b>xi</b>

## 安全须知

- 请勿在任何非规定条件下操作本产品。不遵守此注意事项可能会导致漏电、触电、火灾、溢水或其他问题。
- 如果水池、SPA 或槽内有人，切勿启动本产品。如果发生漏电，可能导致人员死亡或重伤。
- 请勿将本泵用于可燃物的抽吸、移动。
- 请勿用泵输送不低于 40°C 的液体。否则，可能导致泵的组成部件损坏或操作人员受重伤。
- 请勿在铭牌上所示电压（电压容许限度为  $\pm 5\%$  以内）除外的任何电压下操作本产品。如果使用发电机进行操作，强烈建议不要使用同一发电机操作其他设备。否则可能造成产品故障和损坏，从而导致漏电或触电。
- 所有电气工程（包括电缆延伸）都必须由授权电工进行，并遵照贵国的所有现行法规。切勿允许未授权人员进行电气工程，因为这不仅违法，而且极其危险。
- 请务必提供适合泵的专用接地漏电断路器（额定灵敏电流不得超过 30 mA）和热过载继电器（两者均为市售品）。不遵守此警告会在发生产品故障或漏电时造成触电或爆炸。
- 请提供本产品专用的可靠接地点。请勿将地线连接到煤气管、水管、避雷针或电话地线。接地不当会造成触电。
- 请勿使用已损坏或装配不紧密的电缆、电源插头或电源插座。损坏的电缆必须由有资格的人员进行更换。请将电缆的每根导线牢固连接至各端子。否则会导致触电、短路或火灾。
- 切勿将电缆的末端或电源插头浸入水中。这可能会导致产品损坏、漏电、触电或火灾。
- 请勿擦伤、折叠、拉扯、扭曲、改装或捆扎电缆，或将其用作吊具。否则电缆可能会损坏，因而造成漏电、短路、触电或火灾。
- 开始维护或检查之前，请务必关闭电源或断开插头，这样泵就不会意外启动。请勿湿手作业。若不遵守这些注意事项可能导致触电或伤害。

## 為確保您的安全請務必閱讀下列資訊

- 請勿在指定狀況之外的任何狀況下操作本產品。若不遵守本注意事項可能導致漏電、電擊、火災、溢水或其他問題。
- 若水池、SPA 或槽中有人，請絕對不要啟動本產品。萬一發生漏電，可能會使其受重傷或死亡。
- 請勿使用本泵抽取或輸送可燃性物質。
- 40°C以上的液體，請勿使用泵進行送液。否則可能會使泵的組成零件受損，或使操作者受重傷。
- 請勿在銘牌上所述電壓（容許限度  $\pm 5\%$ ）之外的任何電壓之下操作本產品。若用發電機來進行操作，強烈建議勿以相同發電機操作其他設備。若不遵守本注意事項可能造成產品故障和損壞，進而導致漏電或電擊。
- 所有電氣工作（包括纜線延長）必須由獲授權電工依據貴國所有適用法規來執行。絕勿允許未獲授權人員執行電氣工作，因為這不僅違法，更是極度危險。
- 請務必提供適合泵的專用接地漏電斷路器（具有不超過 30 mA 的額定靈敏度電流）以及熱過載繼電器（這兩種裝置可在市面上買到）。若不依循本警告事項，產品發生故障或漏電時，可能造成電擊或爆炸。
- 請為本產品提供專用的可靠接地點。請勿將接地線連接到瓦斯管、水管、避雷針或電話接地線。接地不當可能造成電擊。
- 如果纜線、電源插頭或電源插座損壞或無法緊密吻合，請勿使用。損壞的纜線必須由合格人員予以更換。請將纜線的每一根導線安全連接到端子上。若未能遵守這一點，可能造成電擊、短路或火災。
- 絕勿將纜線末端或電源插頭浸入水中。否則可能造成產品損壞、漏電、電擊或火災。
- 請勿刮傷、折疊、拉動、扭轉、改裝或捆束纜線，或將纜線作為吊具使用。否則纜線可能損壞，進而造成漏電、短路、電擊或火災。
- 開始維護或檢查之前，請務必關閉電源或拔出插頭，以避免泵意外啟動。請勿以濕手工作。若不遵守這些注意事項，可能造成電擊或傷害。

## HÃY ĐỌC KỸ ĐỂ ĐẢM BẢO AN TOÀN CHO BẠN

- Không vận hành sản phẩm trong bất kỳ điều kiện nào ngoài những điều kiện được chỉ định. Không tuân thủ các quy tắc phòng ngừa có thể dẫn đến rò rỉ điện, điện giật, hỏa hoạn, tràn nước hoặc các vấn đề khác.
- Tuyệt đối không cố vận hành sản phẩm khi có người đang ở trong hồ bơi, spa hoặc bể chứa. Nếu xảy ra rò điện có thể dẫn đến tử vong hoặc thương tích nghiêm trọng.
- Không sử dụng máy bơm này để bơm hoặc di chuyển các vật liệu dễ cháy.
- Không sử dụng máy bơm này để bơm chất lỏng có nhiệt độ từ 40°C trở lên. Làm như vậy có thể làm hỏng các bộ phận cấu thành máy bơm hoặc làm người vận hành bị thương nghiêm trọng.
- Không vận hành sản phẩm ở điện áp khác với điện áp được ghi trên tem nhãn với giới hạn dung sai điện áp trong khoảng  $\pm 5\%$ . Nếu vận hành với máy phát điện, chúng tôi đặc biệt khuyến cáo bạn không nên vận hành thiết bị nào khác với cùng máy phát điện này. Không tuân thủ các quy tắc phòng ngừa có thể gây ra trục trặc và hư hỏng sản phẩm, điều này có thể dẫn đến rò rỉ điện hay điện giật.
- Tất cả các công việc liên quan đến điện (bao gồm cả nối dài cáp) phải được thực hiện bởi thợ điện có chuyên môn và phải tuân thủ tất cả các quy định tại quốc gia của bạn. Tuyệt đối không được để một người thợ điện không có chuyên môn thực hiện công việc này vì điều này không chỉ trái pháp luật mà còn có thể cực kỳ nguy hiểm.
- Nhất định phải sử dụng cầu dao chống rò điện đất chuyên dụng (có độ nhạy dòng điện không vượt quá 30 mA) và rơ le nhiệt bảo vệ quá tải phù hợp với máy bơm (cả hai đều có sẵn trên thị trường). Không tuân thủ theo cảnh báo này có thể gây điện giật hoặc cháy nổ khi sản phẩm hư hỏng hoặc xảy ra rò rỉ điện.
- Sử dụng thiết bị nối đất an toàn chuyên dụng cho sản phẩm. Không gắn dây nối đất với ống dẫn ga, ống nước, cột thu lôi hoặc dây nối đất của điện thoại. Nối đất không đúng cách có thể gây điện giật.
- Không sử dụng dây cáp, phích cắm điện hoặc ổ cắm điện nếu các thiết bị này bị hỏng hay không được gắn chặt. Cáp bị hỏng phải được thay bởi thợ có tay nghề. Kết nối tất cả dây dẫn của cáp với các thiết bị đầu cuối một cách chắc chắn. Không tuân thủ các bước này có thể dẫn đến giật điện, chập điện hoặc hỏa hoạn.
- Tuyệt đối không để các đầu dây cáp hoặc phích cắm điện bị nhúng nước. Điều này có thể làm hư hỏng sản phẩm, rò rỉ điện, giật điện hoặc hỏa hoạn.
- Không làm xước, gập, kéo, xoắn, làm biến dạng hoặc bó các sợi cáp, hoặc sử dụng dây cáp như một thiết bị nâng. Dây cáp có thể bị hư hỏng, dẫn đến các sự cố rò rỉ điện, chập điện, giật điện hoặc hỏa hoạn.
- Trước khi bắt đầu bảo trì hay kiểm tra, nhất định phải tắt nguồn điện hoặc rút phích cắm điện, tránh trường hợp máy bơm vô tình khởi động. Không làm việc với tay ướt. Không tuân thủ các bước này có thể dẫn đến giật điện hoặc bị thương.

## กรุณาอ่านข้อความนี้เพื่อความปลอดภัยของคุณ

- ห้ามใช้งานผลิตภัณฑ์ภายใต้สภาวะอื่นใดนอกเหนือจากที่ระบุไว้ หากไม่สามารถปฏิบัติตามข้อควรระวัง อาจส่งผลให้เกิดไฟรั่ว ไฟช็อต เพลิงไหม้ น้ำล้น หรือปัญหาอื่นๆ ได้
- กรุณาไม่เริ่มต้นใช้ผลิตภัณฑ์หากมีคนอยู่ในสระน้ำ, สปา หรืออ่างโดยเด็ดขาด อาจเกิดเหตุการณ์ไฟฟ้ารั่วและถึงแก่ชีวิตได้
- กรุณาอย่าใช้ปั้มน้ำ บีบหรือเคลื่อนย้ายสิ่งของที่ติดไฟได้
- กรุณาอย่าบีบของเหลวที่มีอุณหภูมิสูงกว่า 40 องศาเซลเซียส หากเกิดเหตุการณ์นี้ขึ้น อาจเกิดความเสียหายขึ้นกับชิ้นส่วนของปั้ม หรือทำให้ผู้ปฏิบัติงานได้รับบาดเจ็บสาหัส
- ห้ามใช้งานผลิตภัณฑ์ภายใต้แรงดันไฟฟ้าอื่นใดนอกเหนือจากที่ระบุไว้บนป้าย ซึ่งมีเกณฑ์ความคลาดเคลื่อนของแรงดันไฟฟ้าอยู่ที่  $\pm 5\%$  หากมีการใช้งานกับเครื่องกำเนิดไฟฟ้า แนะนำเป็นอย่างยิ่งว่าไม่ให้ใช้งานกับอุปกรณ์อื่นด้วยเครื่องกำเนิดไฟฟ้าเครื่องเดียวกัน หากไม่สามารถปฏิบัติตามคำแนะนำนี้อาจส่งผลให้เกิดการทำงานผิดปกติ และผลิตภัณฑ์พังเสียหาย ซึ่งส่งผลให้เกิดไฟรั่วหรือไฟช็อตได้
- งานด้านไฟฟ้าทั้งหมด(รวมไปถึงการต่อสายเคเบิล) จะต้องดำเนินการโดยช่างไฟฟ้าที่ได้รับอนุญาต ซึ่งเป็นการปฏิบัติตามระเบียบที่มีการกำหนดไว้ในประเทศของคุณ ห้ามไม่ให้ผู้ที่มิได้รับอนุญาตดำเนินงานด้านไฟฟ้าโดยเด็ดขาด เพราะไม่เพียงแต่จะเป็นการฝ่าฝืนกฎหมาย แต่ยังอาจเกิดอันตรายอย่างยิ่งได้ด้วย
- จัดให้มีการใช้เบรกเกอร์แบบมีระบบสายดินโดยเฉพาะ (โดยมีกระแสรั่วไหลได้ไม่เกิน 30mA) และใช้อิโวลต์รีโวลต์รีเลย์แบบทำงานด้วยความร้อนที่เหมาะสมกับขนาดของปั้ม (อุปกรณ์ทั้งสองชนิดนี้มีจำหน่ายทั่วไป) หากไม่สามารถปฏิบัติตามสัญญาณเตือนนี้ อาจส่งผลให้เกิดไฟช็อต หรือระเบิดเมื่อผลิตภัณฑ์ไม่สามารถทำงานหรือเกิดไฟรั่วได้
- จัดให้มีระบบสายดินที่ปลอดภัยสำหรับผลิตภัณฑ์นี้โดยเฉพาะ ห้ามเชื่อมต่อสายดินเข้ากับท่อก๊าซ ท่อน้ำ สายล่อฟ้า หรือสายดินของโทรศัพท์ ระบบสายดินที่ไม่เหมาะสมอาจทำให้เกิดไฟช็อตได้
- ห้ามใช้สายเคเบิล ปลั๊กไฟ หรือเต้าเสียบที่ชำรุดหรือหลวม สำหรับสายเคเบิลที่ชำรุดจะต้องมีการเปลี่ยนด้วยบุคลากรที่มีคุณสมบัติครบถ้วน ให้เชื่อมต่อสายตัวนำทุกตัวของสายเคเบิลเข้ากับขั้วต่อให้แน่นหนา หากไม่สามารถปฏิบัติตามได้ อาจส่งผลให้เกิดไฟช็อต ไฟลัดวงจร หรือเพลิงไหม้ได้
- ห้ามจุ่มปลายของสายเคเบิลหรือปลั๊กไฟลงในน้ำโดยเด็ดขาด การกระทำดังกล่าวอาจส่งผลให้ผลิตภัณฑ์ชำรุดเสียหาย ไฟรั่ว ไฟช็อต หรือเพลิงไหม้ได้
- ห้ามครูด พับ ดึง บิด ตัดแปลง หรือมัดรวมสายเคเบิล หรือใช้เป็นอุปกรณ์สำหรับยกของ สายเคเบิลอาจชำรุด ซึ่งเป็นเหตุให้เกิดไฟรั่ว ไฟลัดวงจร ไฟช็อต หรือเพลิงไหม้ได้
- ก่อนเริ่มการซ่อมบำรุงหรือตรวจสอบใดๆ ให้ปิดแหล่งจ่ายไฟให้สนิทหรือถอดปลั๊ก เพื่อป้องกันไม่ให้ปั้มเริ่มทำงานโดยบังเอิญ และห้ามใช้งานขณะมือเปียก หากไม่สามารถปฏิบัติตามคำแนะนำนี้อาจส่งผลให้เกิดไฟช็อต หรือเกิดการบาดเจ็บได้

## **PASTIKAN UNTUK MEMBACA DEMI KESELAMATAN ANDA**

- **Jangan operasikan produk dalam kondisi apa pun selain dari yang ditentukan. Kegagalan untuk mematuhi tindakan pencegahan dapat menyebabkan kebocoran listrik, sengatan listrik, kebakaran, luapan air atau masalah lainnya.**
- **Jangan pernah mencoba mengoperasikan produk jika seseorang berada di kolam, spa atau tangki. Jika terjadi kebocoran listrik, hal itu dapat menyebabkan kematian atau cedera serius.**
- **Jangan gunakan pompa ini untuk memompa atau memindahkan bahan yang mudah terbakar.**
- **Jangan memompa cairan bersuhu 40°C atau lebih. Bila hal ini dilakukan, komponen pompa dapat rusak atau melukai operator secara serius.**
- **Jangan operasikan produk dalam tegangan apa pun selain yang dijelaskan pada papan nama dengan batas toleransi tegangan  $\pm 5\%$ . Jika dioperasikan dengan generator, sangat disarankan untuk tidak mengoperasikan peralatan lain dengan generator yang sama. Kegagalan mematuhi peringatan ini dapat menyebabkan kegagalan fungsi dan kerusakan produk, yang dapat menyebabkan kebocoran listrik atau sengatan listrik.**
- **Semua pekerjaan listrik (termasuk ekstensi kabel) harus dilakukan oleh ahli listrik yang berwenang, sesuai dengan semua peraturan yang berlaku di negara Anda. Jangan pernah mengizinkan orang yang tidak berwenang melakukan pekerjaan listrik karena tidak hanya melanggar hukum, tetapi juga bisa sangat berbahaya.**
- **Benar-benar menyediakan pemutus sirkuit kebocoran tanah khusus (memiliki arus sensitivitas terukur tidak melebihi 30 mA) dan relai kelebihan beban termal yang cocok untuk pompa (keduanya tersedia di pasar). Gagal mengikuti peringatan ini dapat menyebabkan sengatan listrik atau ledakan ketika produk gagal atau terjadi kebocoran listrik.**
- **Berikan pentanahan aman yang didedikasikan untuk produk. Jangan hubungkan kabel arde ke pipa gas, pipa air, penangkal petir, atau kabel arde telepon. Pentanahan yang tidak benar dapat menyebabkan sengatan listrik.**
- **Jangan gunakan kabel, steker listrik, atau stopkontak jika rusak atau tidak dipasang dengan erat. Kabel yang rusak harus diganti oleh orang yang berwenang. Hubungkan setiap konduktor kabel dengan aman ke terminal. Kegagalan untuk mengamati ini dapat menyebabkan sengatan listrik, hubungan pendek, atau kebakaran.**
- **Jangan pernah merendam ujung kabel atau steker listrik ke dalam air. Ini dapat menyebabkan kerusakan pada produk, kebocoran listrik, sengatan listrik, atau kebakaran.**
- **Jangan menggores, melipat, menarik, memelintir, membuat perubahan, atau mengikat kabel, atau menggunakannya sebagai alat pengangkat. Kabel mungkin rusak, yang dapat menyebabkan kebocoran listrik, hubungan pendek, sengatan listrik, atau kebakaran.**
- **Sebelum memulai perawatan atau inspeksi, matikan catu daya sepenuhnya atau lepaskan steker sehingga pompa tidak dapat memulai secara tidak sengaja. Jangan bekerja dengan tangan basah. Gagal mematuhi peringatan ini dapat menyebabkan sengatan listrik atau cedera.**

## **PASTIKAN ANDA MEMBACA UNTUK KESELAMATAN ANDA**

- Jangan mengoperasikan produk dalam keadaan apa-apa syarat selain daripada yang dinyatakan. Kegagalan untuk mematuhi langkah berjaga-jaga boleh menyebabkan kebocoran elektrik, kejutan elektrik, kebakaran, limpahan air atau masalah lain.
- Jangan pernah cuba mengoperasikan produk jika ada orang di kolam, spa atau tangki. Sekiranya kebocoran elektrik berlaku, ia boleh menyebabkan kematian atau kecederaan serius.
- Jangan gunakan pam ini untuk mengepam atau menggerakkan bahan mudah terbakar.
- Jangan mengepam cecair dengan suhu 40°C ke atas. Melakukannya boleh merosakkan komponen pam atau mencederakan operator secara serius.
- Jangan operasikan produk di bawah mana-mana voltan selain daripada yang dinyatakan pada papan nama dengan had toleransi voltan  $\pm 5\%$ . Jika ia dioperasikan dengan generator, sangat disyorkan untuk tidak mengoperasikan peralatan lain dengan generator yang sama. Kegagalan mematuhi amaran ini boleh menyebabkan pincang tugas dan kerosakan produk, yang mungkin menyebabkan kebocoran elektrik atau kejutan elektrik.
- Semua kerja elektrik (termasuk sambungan kabel) mesti dilakukan oleh juruelektrik yang diberi kuasa, selaras dengan semua peraturan yang berlaku di negara anda. Jangan sekali-kali membenarkan seseorang yang tidak dibenarkan melakukan kerja elektrik kerana ia bukan sahaja melanggar undang-undang, tetapi ia juga boleh menjadi sangat berbahaya.
- Pastikan untuk benar memberikan pemutus litar kebocoran bumi khusus (mempunyai kepekaan arus yang tidak melebihi 30 mA) dan relai beban lebih terma yang sesuai untuk pam (kedua-duanya terdapat di pasaran). Kegagalan mematuhi peringatan ini boleh menyebabkan kejutan atau letupan elektrik apabila produk gagal atau kebocoran elektrik berlaku.
- Sediakan grounding yang selamat untuk produk. Jangan sambungkan dawai tanah ke paip gas, paip air, tongkat cahaya, atau dawai tanah telefon. Grounding yang salah boleh menyebabkan kejutan elektrik.
- Jangan gunakan kabel, palam kuasa atau soket kuasa jika rosak atau tidak dipasang dengan teliti. Kabel yang rosak mesti diganti oleh orang yang berkelulusan. Sambung setiap konduktor kabel dengan selamat ke terminal. Kegagalan mematuhi perkara ini boleh menyebabkan kejutan elektrik, litar pintas, atau kebakaran.
- Jangan menenggelamkan hujung kabel atau palam kuasa di dalam air. Ini boleh mengakibatkan kerosakan produk, kebocoran elektrik, kejutan elektrik, atau kebakaran.
- Jangan menggores, melipat, tarik, memutar, membuat perubahan, atau mengikat kabel, atau menggunakannya sebagai peranti untuk mengangkat. Kabel mungkin akan rosak, yang boleh menyebabkan kebocoran elektrik, litar pintas, kejutan elektrik, atau kebakaran.
- Sebelum memulakan penyenggaraan atau pemeriksaan, matikan bekalan kuasa sepenuhnya atau cabut palam supaya pam tidak boleh bermula secara tidak sengaja. Jangan bekerja dengan tangan basah. Kegagalan mematuhi peringatan ini boleh membawa kepada kejutan atau kecederaan elektrik.



## **SIGURUHING BASAHIN PARA SA SARILING KALIGTASAN**

- Huwag gamitin ang produkto sa anumang kondisyon maliban sa itinakdang gamit nito. Kapag hindi sinunod ang mga babala, maaaring maging sanhi ito ng pagkakaroon ng electrical leakage, electrical shock, sunog, pag-apaw ng tubig at iba pang mga problema.
- Huwag paandarin ang produkto kapag may tao sa loob ng pool, spa o tangke. Maaaring maging sanhi ng pagkamatay o malubhang pinsala kapag nagkaroon ng pagtagas ng elektrisidad.
- Huwag gamitin ang pump sa pagbomba o paglipat sa mga bagay na nasusunog.
- Huwag gamitin sa pagbomba ng likido na lampas sa 40. Kapag ginawa ito ay maaaring masira ang mga piyesa ng pump o di kaya'y magdulot ng malubhang pinsala sa gumagamit ng pump.
- Huwag gamitin ang produkto sa anumang boltahe maliban sa itinakdang boltahe na nakalarawan sa nameplate na may voltage tolerance limit na nasa loob ng  $\pm 5\%$ . Kapag ginamitan ng generator, mahigpit na ipinapayo na iwasan ang paggamit ng ibang kagamitan sa parehong generator. Kapag hindi sinunod ang mga babala, maaaring masira o hindi gumana nang husto ang produkto, at maging sanhi ng pagkakaroon ng electrical leakage o electrical shock.
- Ang lahat ng gawain kaugnay sa elektrisidad (pati ang cable extension) ay kailangang gawin ng isang authorized electrician, sang-ayon sa mga naaangkop na regulasyon sa sariling bansa. Huwag itong ipagawa sa isang taong walang sapat na kuwalipikasyon sa paggawa ng electrical work, dahil hindi lamang ito labag sa batas kundi masyadong mapanganib.
- Kailangang maglaan ng isang dedicated earth leakage circuit breaker (na may rated sensitivity current na hindi lalampas sa 30 mA) at may thermal overload relay na nababagay sa pump (ibinibenta sa mga tindahan). Kapag hindi sinunod ang mga babala, maaaring maging sanhi ito ng pagkakaroon ng electrical shock o pagsabog sa kapag nagkaroon ng problema sa produkto o kapag nagkaroon ng electrical leakage.
- Gumawa ng isang secure grounding para lamang sa produkto. Huwag ikabit ang ground wire sa tubo ng gas o tubig, lightning rod, o telephone ground wire. Maaaring maging sanhi ng electrical shock ang hindi pagtatag ng tamang grounding.
- Huwag gumamit ng cable, power plug, or power outlet kapag ito ay sira na, o kapag hindi maayos ang pagkakakabit nito. Ang pagpalit ng cable ay kailangang gawin ng isang taong may sapat na kuwalipikasyon. Ikabit nang maigi ang bawat conductor ng cable sa mga terminals. Kapag hindi sinunod ang mga babala, maaaring maging sanhi ito ng pagkakaroon ng electrical shock, short circuit o sunog.
- Huwag ilubog sa tubig ang dulo ng cable o power plug. Maaari itong maging sanhi ng pagkasira ng produkto, pagkakaroon ng electrical leakage, electrical shock, o sunog.
- Huwag gasgasin, tupiin, hilahin, ibaluktot, baguhin o ibigkis ang cable o di kaya'y gamitin ito bilang isang lifting device. Maaaring masira ang cable, na maging sanhi ng pagkakaroon ng electrical leakage, short circuit, electrical shock, o sunog.
- Bago umpisahan ang maintenance o pagsusuri, kailangang patayin ang power supply o tanggalin ang plug upang maiwasan ang hindi sinasadyang pag-andar ng pump. Huwag gumawa kapag basa ang mga kamay. Kapag hindi sinunod ang mga babala, maaaring maging sanhi ito ng pagkakaroon ng electrical shock, o pagkapinsala.

## تأكد من القراءة من أجل سلامتك

- لا تقم بتشغيل المنتج تحت أية ظروف بخلاف تلك المحددة له. قد يؤدي عدم مراعاة الاحتياطات إلى حدوث تسرب كهربائي أو صدمة كهربائية أو نشوب حريق أو فيضان الماء أو وقوع مشكلات أخرى.
- لا تحاول مطلقاً تشغيل المنتج عند وجود شخص ما في حمام السباحة أو الحمام المعدني أو الحوض. إذا حدث تسرب كهربائي، فقد يتسبب في الوفاة أو وقوع إصابة خطيرة.
- لا تستخدم هذه المضخة لضخ/نقل أي مواد قابلة للاشتعال.
- لا تقم بضخ سوائل تزيد درجة حرارتها عن 40 درجة مئوية. القيام بذلك قد يتسبب في إلحاق ضرر بمكونات المضخة أو تعرض المشغل لإصابة خطيرة.
- لا تقم بتشغيل المنتج تحت أي جهد بخلاف ما هو موضح على اللوحة، على أن يكون حد تحمل الجهد ضمن  $\pm 5\%$ . إذا تم تشغيله باستخدام مولد، يُنصح بشدة بعدم تشغيل معدات أخرى باستخدام نفس المولد. عدم مراعاة هذا التنبيه قد يؤدي إلى حدوث خلل للمنتج وتعطله، مما قد يؤدي بدوره إلى حدوث تسرب كهربائي أو صدمة كهربائية.
- يجب أن يقوم كهربائي معتمد بتنفيذ جميع الأعمال الكهربائية (بما في ذلك توصيل الكابلات)، وفقاً لجميع اللوائح المعمول بها في بلدك لا تسمح أبداً لشخص غير معتمد بأداء الأعمال الكهربائية ليس فقط لكون ذلك مخالفاً للقانون، بل لأنه قد يشكل خطورة شديدة أيضاً.
- قم بتجهيز قاطع دائرة تسرب أرضي مخصص (به تيار حساسية مُقدَّر لا يتجاوز 30 ملي أمبير) ومرحل حراري يعمل عند تجاوز الحمل مناسب للمضخة (كلاهما متاح في السوق). قد يؤدي عدم اتباع هذا التحذير إلى حدوث صدمة كهربائية أو انفجار إذا فشل المنتج في أداء وظيفته أو إذا حدث تسرب كهربائي.
- قم بتوفير تأريض آمن مخصص للمنتج. لا تقم بتوصيل سلك التأريض بأنبوب غاز أو أنبوب ماء أو مانع صواعق أو سلك تأريض الهاتف التأريض بطريقة غير سليمة قد يسبب صدمة كهربائية.
- لا تستخدم الكابل أو قابس الطاقة أو مأخذ الطاقة إذا كان تالفاً أو إذا لم يكن مركباً بإحكام. يجب أن يتم استبدال الكابل التالف بواسطة شخص مؤهل. قم بتوصيل كل موصل من موصلات الكابل إلى الأطراف بشكل آمن. عدم مراعاة هذا قد يؤدي إلى حدوث صدمة كهربائية أو دائرة قصر أو نشوب حريق.
- لا تعتمد مطلقاً على غمر طرفي الكابل أو قابس الطاقة في الماء. قد يؤدي هذا إلى تلف المنتج أو حدوث تسرب كهربائي أو صدمة كهربائية أو نشوب حريق.
- لا تعتمد على خدش الكابل أو طيه أو سحبه أو ثنيه أو إجراء تعديلات عليه أو تجميعه، أو استخدامه كجهاز رفع. قد يكون الكابل تالفاً مما قد يتسبب في حدوث تسرب كهربائي أو دائرة قصر أو صدمة كهربائية أو نشوب حريق.
- قبل بدء الصيانة أو الفحص، قم بقطع تزويد الطاقة بالكامل أو قم بفصل القابس حتى لا يبدأ تشغيل المضخة بشكل غير مقصود لا تقم بمباشرة العمل حين تكون يداك مبللتين. عدم مراعاة هذه التنبيهات قد يؤدي إلى حدوث صدمة كهربائية أو إصابة.

## **ASEGÚRESE DE LEER LA SIGUIENTE INFORMACIÓN PARA SU SEGURIDAD**

- No manipule el producto en condiciones distintas a las que ha sido diseñado. El incumplimiento de esta precaución puede ocasionar fugas eléctricas, descargas eléctricas, incendios, desbordamientos de agua u otros problemas.
- Nunca intente operar el producto si hay alguien presente en la pileta (piscina), spa o tanque. Si se ocasiona una fuga eléctrica, puede producir la muerte o heridas graves.
- No utilice esta bomba para bombear ni transportar nada inflamable.
- No bombee líquido que tenga más de 40 °C. Si lo hace, puede ocasionarle heridas graves al operador o daños a los componentes de la bomba.
- No manipule el producto en un voltaje diferente al indicado en la placa de identificación. Utilícelo dentro del rango de tolerancia de voltaje de  $\pm 5\%$ . Si se manipula con un generador, se recomienda encarecidamente no operar otros equipos con el mismo generador. El incumplimiento de esta precaución puede causar el mal funcionamiento y la falla del producto, lo que podría ocasionar fugas o descargas eléctricas.
- Todos los trabajos de electricidad (incluida la instalación del cable de extensión) deben ser realizados por un electricista autorizado, en conformidad con las regulaciones aplicables en su país. Nunca permita que una persona no autorizada realice trabajos eléctricos porque, no solo es ilegal, sino que puede ser extremadamente peligroso.
- Asegúrese de instalar un disyuntor específico de fuga a tierra (con sensibilidad nominal no superior a 30 mA) y un relé de sobrecarga térmica adecuado para la bomba (ambos disponibles en el mercado). El incumplimiento de esta advertencia puede ocasionar descargas eléctricas o explosiones cuando el producto falla o se produce una fuga eléctrica.
- Instale una conexión a tierra segura y específica para el producto. No conecte el cable de tierra a una tubería de gas, tubería de agua, pararrayos o cable de tierra del teléfono. Una conexión a tierra incorrecta podría causar descargas eléctricas.
- No utilice el cable, el enchufe o la toma de corriente si están dañados o si no están bien ajustados. Los cables dañados deben ser reemplazados por una persona calificada. Conecte cuidadosamente cada conductor del cable a los terminales. De lo contrario, se podrían producir descargas eléctricas, cortocircuitos o incendios.
- Nunca sumerja los extremos de un cable o el enchufe en agua. Esto podría ocasionar daños en el producto, fugas eléctricas, descargas eléctricas o incendios.
- No raye, doble, hale, tuerza, altere ni enrolle el cable, ni lo use como dispositivo de elevación. El cable podría dañarse, ocasionando fugas eléctricas, cortocircuitos, descargas eléctricas o incendios.
- Antes de comenzar el mantenimiento o la inspección, asegúrese de apagar la fuente de alimentación o desconectar el enchufe para que la bomba no arranque accidentalmente. No trabaje con las manos mojadas. El incumplimiento de estas precauciones podría ocasionar descargas eléctricas o lesiones.

## **ASSUREZ-VOUS DE LIRE CE DOCUMENT POUR VOTRE SÉCURITÉ**

- **N'utilisez pas le produit dans des conditions autres que celles pour lesquelles il est spécifié. Le non-respect de cette précaution peut entraîner une dispersion électrique, une électrocution, un incendie, une inondation ou d'autres problèmes.**
- **Ne jamais mettre en marche ce produit lorsqu'une personne est présente dans la piscine, le spa ou le bassin. Ceci risque d'entraîner des blessures graves ou la mort par électrocution.**
- **Ne pas utiliser cette pompe pour pomper ou transférer des liquides inflammables.**
- **Ne pas pomper des liquides ayant une température supérieure à 40 °C. Ceci risque d'entraîner une détérioration des éléments internes de la pompe ou de blesser gravement l'opérateur.**
- **Ne faites pas fonctionner le produit sous une tension autre que celle indiquée sur la plaque signalétique dans une limite de tolérance inférieure à  $\pm 5$  %. Si vous utilisez un groupe électrogène, il est fortement recommandé de ne pas utiliser d'autres équipements avec le même groupe électrogène. Le non-respect de cet avertissement peut provoquer un dysfonctionnement et une panne de l'appareil, pouvant entraîner une dispersion électrique ou une électrocution.**
- **Tous les travaux électriques (y compris l'extension des câbles) doivent être effectués par un électricien agréé, conformément à toutes les réglementations en vigueur dans votre pays. Ne permettez jamais à une personne non autorisée d'effectuer des travaux électriques, car non seulement c'est illégal, mais cela peut aussi être extrêmement dangereux.**
- **Prévoir absolument un disjoncteur différentiel dédié (avec une sensibilité nominale ne dépassant pas 30 mA) et un relais thermique de surcharge adapté à la pompe (tous deux disponibles dans le commerce). Le non-respect de cet avertissement peut provoquer une électrocution ou une explosion en cas de défaillance du produit ou de dispersion électrique.**
- **Fournir une mise à la terre sécurisée dédiée au produit. Ne branchez pas le fil de terre à une conduite de gaz ou d'eau, à un paratonnerre ou à un fil de terre de téléphone. Une mise à la terre incorrecte peut provoquer une électrocution.**
- **N'utilisez pas le câble, la fiche d'alimentation ou la prise de courant s'ils sont endommagés ou s'ils ne sont pas bien fixés. Tout câble endommagé doit être remplacé par une personne qualifiée. Raccordez solidement chaque conducteur du câble aux bornes. Le non-respect de cette consigne peut entraîner une électrocution, un court-circuit ou un incendie.**
- **Ne jamais immerger les extrémités d'un câble ou la fiche d'alimentation dans l'eau. Cela pourrait endommager l'appareil, provoquer une dispersion électrique, une électrocution ou un incendie.**
- **Ne pas érafler, plier, tirer, tordre, modifier, mettre en faisceau le câble ou l'utiliser comme dispositif de levage. Le câble peut être endommagé, ce qui peut provoquer une dispersion électrique, un court-circuit, une électrocution ou un incendie.**
- **Avant de commencer l'entretien ou l'inspection, coupez impérativement l'alimentation électrique ou débranchez la prise afin que la pompe ne puisse pas démarrer accidentellement. Ne travaillez pas avec les mains mouillées. Le non-respect de ces mises en garde peut entraîner une électrocution ou des blessures.**

## **ОБЯЗАТЕЛЬНО ПРОЧИТАЙТЕ ДЛЯ ВАШЕЙ СОБСТВЕННОЙ БЕЗОПАСНОСТИ**

- Не пользуйтесь изделием в условиях, отличных от тех, для которых оно предназначено. Несоблюдение данных мер предосторожности может привести к утечке тока, поражению электрическим током, пожару, переливу воды или другим проблемам.
- Никогда не запускайте изделие в бассейне, спа или баке с людьми. Утечка тока может привести к смерти или серьезным травмам.
- Не используйте этот насос для откачивания или перемещения легковоспламеняющихся материалов.
- Не перекачивайте с помощью этого насоса жидкости при температуре свыше 40 °С. Это может привести к повреждению деталей насоса или к травме самого оператора насоса.
- Не используйте изделие под напряжением, отличным от указанного на заводской табличке, при допустимом отклонении напряжения в пределах  $\pm 5\%$ . Если он работает с генератором, настоятельно рекомендуется не использовать другое оборудование с тем же генератором. Несоблюдение данной меры предосторожности может стать причиной неисправности и повреждения изделия, что может привести к утечке или поражению электрическим током.
- Все электромонтажные работы (включая удлинение кабеля) должны выполняться уполномоченным электриком в соответствии со всеми действующими правилами вашей страны. Никогда не позволяйте посторонним лицам выполнять электромонтажные работы, поскольку это не только противоречит закону, но и может быть чрезвычайно опасным.
- Чрезвычайно необходимо предоставить специальный автоматический выключатель для защиты от утечки на землю (имеющий номинальную чувствительность тока не более 30 мА) и тепловое реле перегрузки, подходящее для насоса (оба доступны в продаже). Несоблюдение этого предупреждения может привести к поражению электрическим током или взрыву в случае выхода из строя изделия либо утечки тока.
- Обеспечьте безопасное заземление, предназначенное для изделия. Не подключайте заземляющий провод к газовой трубе, водопроводу, молниеотводу или телефонному заземляющему проводу. Ненадлежащее заземление может привести к поражению электрическим током.
- Не используйте кабель, вилку или розетку, если они повреждены или не плотно прилегают. Поврежденный кабель должен быть заменен квалифицированным персоналом. Надежно подключите каждую жилу кабеля к клеммам. Несоблюдение этого требования может привести к поражению электрическим током, короткому замыканию или возгоранию.
- Никогда не погружайте концы кабеля или вилку в воду. Это может привести к повреждению изделия, утечке тока, поражению электрическим током или пожару.
- Не царапайте, не складывайте, не тяните, не скручивайте, не вносите изменения, не связывайте кабель и не используйте его в качестве подъемного устройства. Кабель может быть поврежден, что может привести к утечке тока, короткому замыканию, поражению электрическим током или пожару.
- Перед началом технического обслуживания или проверки обязательно отключите электропитание или отсоедините штепсельную вилку таким образом, чтобы насос случайно не запустился. Не производите работу мокрыми руками. Несоблюдение данных мер предосторожности может привести к поражению электрическим током или травме.

# 1 BE SURE TO READ FOR YOUR SAFETY

Be sure to thoroughly read and understand the SAFETY PRECAUTIONS given in this section before using the equipment in order to operate the equipment correctly.

The precautionary measures described in this section are intended to prevent danger or damage to you or to others. The contents of this manual that could possibly be performed improperly are classified into two categories: **⚠️ WARNING**, and **⚠️ CAUTION**. The categories indicate the extent of possible damage or the urgency of the precaution. Note however, that what is included under **⚠️ CAUTION** may at times lead to a more serious problem. In either case, the categories pertain to safety-related items, and as such, must be observed carefully.

- **⚠️ WARNING** : Operating the equipment improperly by failing to observe this precaution may possibly lead to death or injury to humans.
- **⚠️ CAUTION** : Operating the equipment improperly by failing to observe this precaution may possibly cause injury to humans and other physical damage.
- **NOTE** : Gives information that does not fall in the WARNING or CAUTION categories.

## ● Explanation of Symbols:

- ⚡ : The ⚠️ mark indicates a WARNING or CAUTION item. The symbol inside the mark describes the precaution in more detail ("electrical shock", in the case of the example on the left).
- ⊘ : The ⊘ mark indicates a prohibited action. The symbol inside the mark, or a notation in the vicinity of the mark describes the precaution in more detail ("disassembly prohibited", in the case of the example on the left).
- ⏚ : The ● mark indicates an action that must be taken, or instructs how to perform a task. The symbol inside the mark describes the precaution in more detail ("provide ground work", in the case of the example on the left).















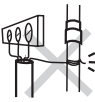



## PRECAUTIONS TO THE PRODUCT SPECIFICATIONS

<b>⚠️ WARNING</b>	
<b>!</b>	● This pump is designed to pump only water that is not intended for human consumption. <b>Other uses can result in injury to the operator or damage to the pump and other property.</b>
<b>⚠️ CAUTION</b>	
<b>⊘</b>	● Do not operate the product under any conditions other than those for which it is specified. <b>Failure to observe the precaution can lead to electrical leakage, electrical shock, fire, water overflow or other problems.</b>



















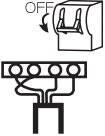



## PRECAUTIONS DURING TRANSPORT AND INSTALLATION

<b>⚠️ WARNING</b>	
<b>!</b>	● When transporting the product, pay close attention to its center of gravity and mass. Use an appropriate lifting equipment to lift the unit. <b>Improper lifting may result in the fall of the product which could cause damage of the product or human injury.</b>
<b>!</b>	● Electrical wiring should be performed in accordance with all applicable regulations in your country. <b>Absolutely provide a dedicated earth leakage circuit breaker and a thermal overload relay suitable for the product (available on the market). Imperfect wiring or improper protective equipment can lead to electrical leakage, fire, or explosion in the worst case.</b>
<b>!</b>	● Install the product properly in accordance with this instruction manual. <b>Improper installation may result in electrical leakage, electrical shock, fire, water leakage, or injury.</b>
<b>⚡</b>	● Provide a secure grounding dedicated for the product. Never fail to provide an earth leakage circuit breaker and a thermal overload relay in your starter or control panel (Both available on the market). <b>If an electrical leakage occurs due to a product failure, it may cause electrical shock.</b>





 <b>WARNING</b>	
	<ul style="list-style-type: none"> <li>● This pump is neither dust-proof nor explosion-proof. Do not use it at a dusty place or at a place where toxic, corrosive or explosive gas is present. <b>Use in such places could cause fire or explosion, resulting in property damage, serious personal injury, and/or death.</b></li> </ul> 
 <b>CAUTION</b>	
	<ul style="list-style-type: none"> <li>● Be sure to provide a ground wire securely. Do not connect the ground wire to a gas pipe, water pipe, lightning rod, or telephone ground wire. <b>Improper grounding could cause electrical shock.</b></li> </ul> 
	<ul style="list-style-type: none"> <li>● Do not scratch, fold, twist, make alterations, or bundle the cable, or use it as a lifting device. <b>The cable may be damaged, which may cause electrical leakage, short-circuit, electrical shock, or</b></li> </ul> 
	<ul style="list-style-type: none"> <li>● When the product will be carried by hand, decide the number of persons considering the mass of the product. When lifting up the product, do not attempt to do it by simply bowing from the waist. <b>Use the knees, too, to protect your back.</b></li> </ul> 
	<ul style="list-style-type: none"> <li>● If a hose is used for the discharge line, take a measure to prevent the hose from shaking. <b>If the hose shakes, you may be wet or injured.</b></li> </ul> 
	<ul style="list-style-type: none"> <li>● Attach a hose securely to the hose coupling. <b>Imperfect connection of hose could cause water leakage which may result in the damage of nearby walls, floors, and other equipment.</b></li> </ul> 
	<ul style="list-style-type: none"> <li>● Do not use the cable if it is damaged. Connect every conductor of the cable securely to the terminals. <b>Failure to observe this can lead to electrical shock, short-circuit, or fire.</b></li> </ul> 
	<ul style="list-style-type: none"> <li>● Use the handle when installing or carrying the pump. Never use the cable to carry or to suspend. <b>Doing so may damage the cable which could cause electrical leakage, short circuit, or fire.</b></li> </ul> 
	<ul style="list-style-type: none"> <li>● Allow the pump to suck as few foreign objects as possible. If there is a risk that the pump could be buried under the sediment, place it on a solid base like concrete block. <b>Failure to do so may result in breakdown of the pump and could cause electrical leakage or short circuit.</b></li> </ul> 

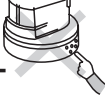

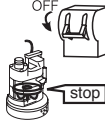

## PRECAUTIONS DURING TEST OPERATION AND OPERATION

 <b>WARNING</b>	
	<ul style="list-style-type: none"> <li>● Never try to operate the product if somebody is present in the pool, spa or sump. <b>If an electrical leakage occurs, it will result in death or serious injury.</b></li> </ul> 
	<ul style="list-style-type: none"> <li>● Never start the pump while it is suspended, as <b>the unit may jerk and could lead to injury.</b></li> </ul> 
	<ul style="list-style-type: none"> <li>● Do not use this pumping equipment to pump/move flammable or explosive liquids such as oil, gasoline, kerosene, ethanol, etc. <b>Using this pump with flammable liquids can cause an explosion or fire, resulting in property damage, serious personal injury, and/or death.</b></li> </ul> 
	<ul style="list-style-type: none"> <li>● When changing power connection is needed to correct the direction of rotation, be sure to turn off the power supply (earth leakage circuit breaker, etc.), and perform the work after making sure that the impeller has stopped completely. <b>Failure to do so may lead to electrical shock, short-circuit, or injury.</b></li> </ul> 
	<ul style="list-style-type: none"> <li>● Do not use the product for hot or warm liquid over 40°C, as <b>doing so will damage the product, which may lead to electrical leakage or electrical shock.</b></li> </ul> 
 <b>CAUTION</b>	
	<ul style="list-style-type: none"> <li>● Do not operate the product under any voltage other than described on the nameplate with the voltage tolerance limit within <math>\pm 5\%</math>. If it is operated with a generator, it is strongly suggested not to operate other equipment with the same generator. <b>Failure to observe this caution may cause malfunction and breakdown of the product, which may lead to electrical leakage or electrical shock.</b></li> </ul> 
	<ul style="list-style-type: none"> <li>● Do not touch the product with bare hands during or immediate after the operation, as the product may become very hot during operation. <b>Failure to observe this caution may lead to burn.</b></li> </ul> 



 <b>CAUTION</b>			
	<ul style="list-style-type: none"> <li>Do not pump oil, salt water, chemicals, corrosives, or organic solvents as media of the sort will damage the pump, which may lead to serious injury.</li> </ul>		<ul style="list-style-type: none"> <li>Do not run the product dry or operate it with its gate valve closed, as <b>doing so will damage the product, which may lead to electrical leakage or electrical shock.</b></li> </ul>
	<ul style="list-style-type: none"> <li>Do not allow foreign object (pin, wire, etc.) to enter the suction inlet of the pump. <b>Failure to observe this caution could cause it to malfunction or to operate abnormally, which may lead to electrical leakage or electrical shock.</b></li> </ul>		<ul style="list-style-type: none"> <li>When the product will not be used for an extended period, be sure to turn off the power supply (earth leakage circuit breaker, etc.). <b>Deterioration of the insulation may lead to electrical leakage, electrical shock, or fire.</b></li> </ul>

## PRECAUTIONS DURING MAINTENANCE AND INSPECTION





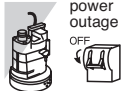

 <b>WARNING</b>			
	<ul style="list-style-type: none"> <li>Absolutely turn off the power supply or disconnect the plug before starting maintenance or inspection. Do not work with wet hands. <b>Failure to observe these cautions may lead to electrical shock or injury.</b></li> </ul>		<ul style="list-style-type: none"> <li>Do not disassemble or repair any parts other than those designated in the operation manual. If repairs are necessary in any other than the designated parts, consult with the dealer where it was purchased or Tsurumi representative. <b>Improper repairs can result in electrical leakage, electrical shock, fire, or water leakage.</b></li> </ul>
	<ul style="list-style-type: none"> <li>In case any abnormality (excessive vibration, unusual noise or odor) is found in the operation, turn the power off immediately and consult with the dealer where it was purchased or Tsurumi representative. <b>Continuing to operate the product under abnormal conditions may result in electrical shock, fire, or water leakage.</b></li> </ul>		

 <b>CAUTION</b>			
	<ul style="list-style-type: none"> <li>After reassembly, always perform a test operation before resuming use of the product. <b>Improper assembly can result in electrical leakage, electrical shock, fire, or water leakage.</b></li> </ul>		

## PRECAUTION TO POWER OUTAGE

 <b>WARNING</b>			
	<ul style="list-style-type: none"> <li>In case of power outage, turn off the power supply. <b>The product will resume operation when the power is restored, which presents serious danger to people in the vicinity.</b></li> </ul>		

## OTHER PRECAUTION

 <b>CAUTION</b>			
	<ul style="list-style-type: none"> <li>Never use the product for potable water. <b>It may present a danger to human health.</b></li> </ul>		
	<ul style="list-style-type: none"> <li>This appliance is not intended or for use by persons (including children) with reduced physical, sensory or mental capabilities, or lack of experience and knowledge, unless they have been given supervision or instruction concerning use of the appliance by a person responsible for their safety.</li> <li>Children should be supervised to ensure that they do not play with the appliance.</li> <li>If the supply cord is damaged, it must be replaced by the manufacturer, its service agent or similarly qualified persons in order to avoid a hazard.</li> <li>Pollution of the liquid could occur due to leakage of lubricants.</li> <li>The pump must be supplied through a residual current device (RCD) having a rated residual operating current not exceeding 30 mA.</li> </ul>		
	<ul style="list-style-type: none"> <li>Do not pump water containing corrosive chemicals or toxic substances. <b>These fluids can cause serious health and environmental hazards. If you need assistance, contact your local authorities.</b></li> </ul>		



## 2 NAME OF PARTS

### ■ Example ; KTV Series

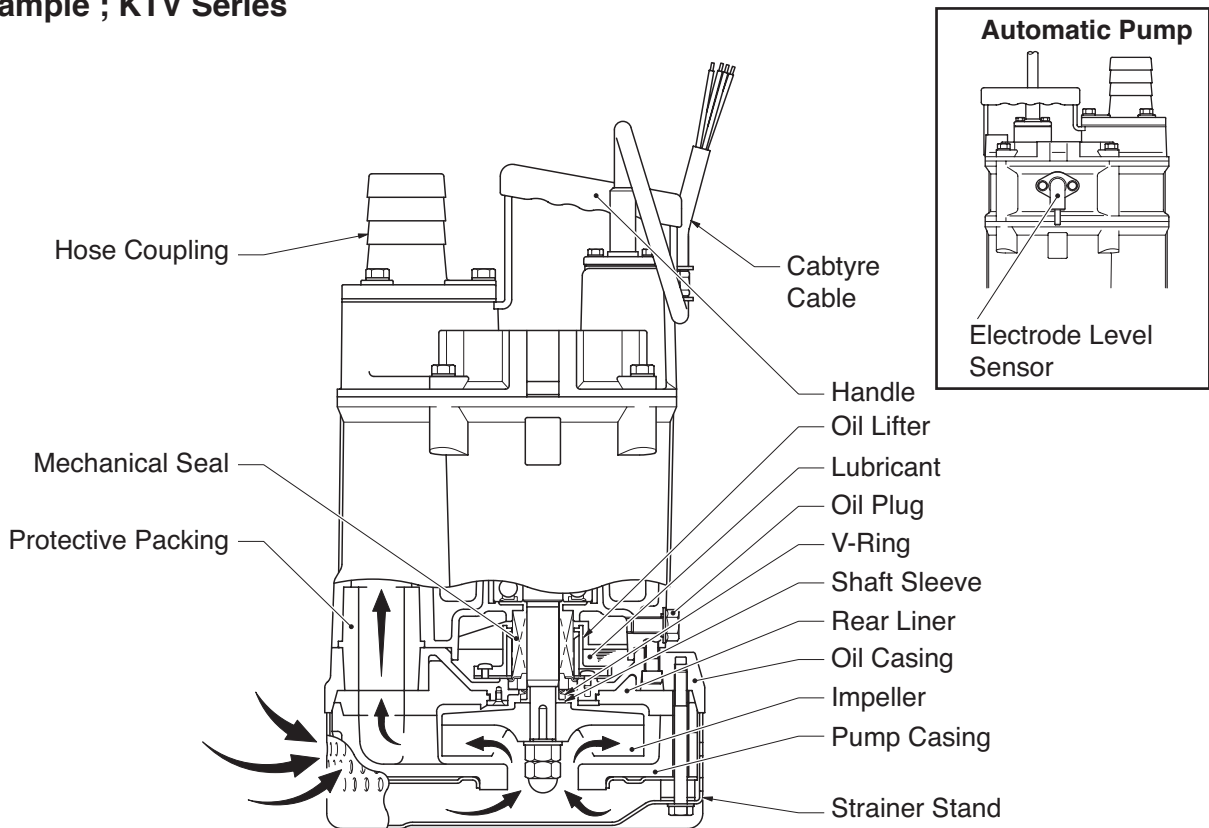

**Note:** The above diagram is typical of the KTV2-22, but some models may vary slightly in appearance or internal structure.

### ■ Example ; NK Series

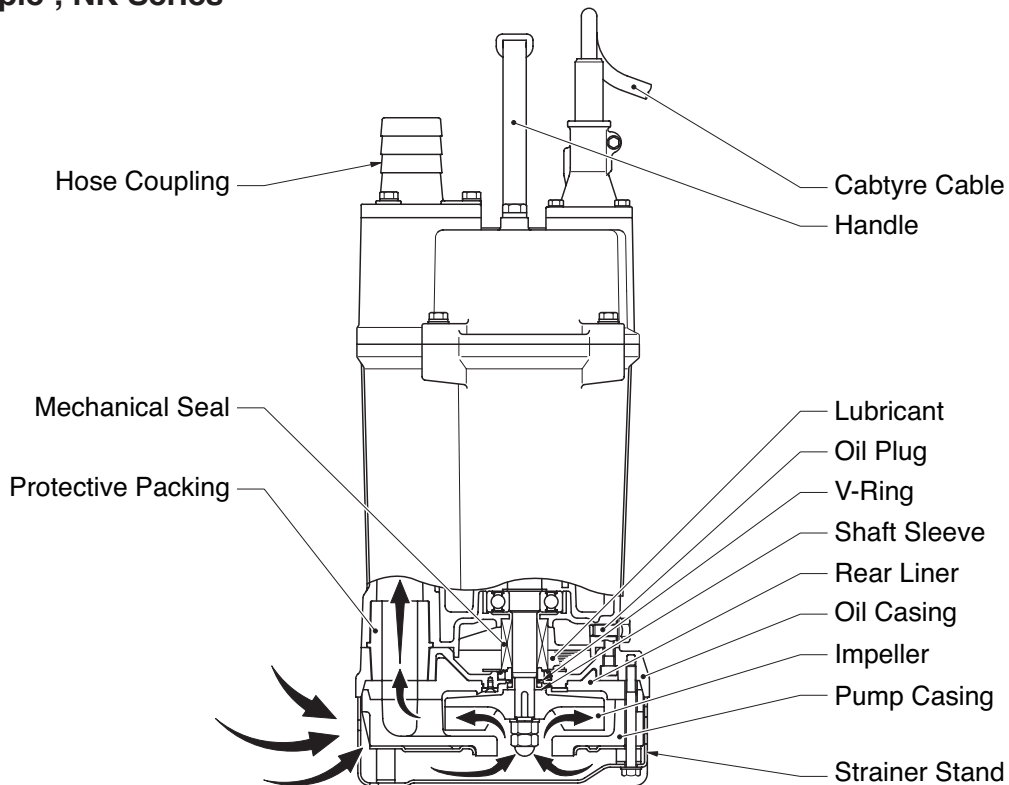

**Note:** The above diagram is typical of the NK4-22, but some models may vary slightly in appearance or internal structure.

### 3 PRIOR TO OPERATION

When the pump is delivered, first perform the following checks.

#### Inspection

While unpacking, inspect the product for damage during shipment, and make sure all bolts and nuts are tightened properly.

#### Specification Check

Check the nameplate of the pump unit to verify that it is the product that you have ordered. Pay particular attention to its voltage and frequency specifications.

#### Example of nameplate

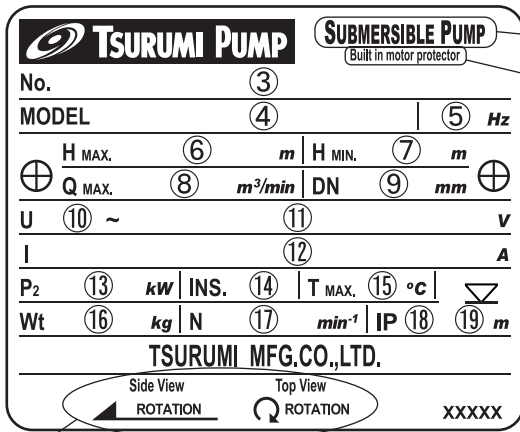

1	Submersible pump	11	Rated voltage
2	Built in motor protector	12	Rated current
3	Serial number	13	Rated output power
4	Model	14	Insulation class
5	Frequency	15	Max. liquid temperature
6	Max. total head	16	Weight without cable
7	Min. total head	17	Speed of rotation
8	Max. flow rate	18	IP degree of protection
9	Discharge bore	19	Max. immersion depth
10	Phase	20	Direction of rotation

**Note:** If there is any problem with the product as shipped, contact your nearest dealer or Tsurumi representative at once.

#### Accessory Check

Verify that all accessory items are included in the package.

- Hose Band (0.75kW) ..... 1 pc Models for US are excluded
- Operation Manual ..... 1

**Note:** If you discover any damage or discrepancy in the product, please contact the dealer where this equipment was purchased or the Tsurumi sales office in your area.

#### Product Specifications

**CAUTION** Do not operate this product under any conditions other than those for which it is specified. Failure to observe this precaution can lead to electrical shock, electrical leakage, fire, water leakage or other problems.

#### Major Standard Specifications

Fluid	Property	Rain water, Ground water, Sand carrying water ; 0 ~ 40°C
Pump	Impeller	Semi-vortex Type
	Shaft Seal	Double Mechanical Seal
	Bearing	Shielded Ball Bearing
Motor	Specification	Dry Type Submersible Induction Motor, 2-pole
	Insulation	Class E (KTV/KTVE Series), Class F (NK Series)
	Protection System (Built-in)	Circle Thermal Protector
	Lubricant	Turbine oil VG32 (non-additive)
Discharge Connection		Hose Coupling

## ■ Specifications - Non-Automatic Pumps (50/60Hz)

Model	Discharge Bore (mm) (inch)	Phase	Starting Method	Output (kW)	Max. Total Head (m) (feet)	Max. Flow Rate (m <sup>3</sup> /min) (GPM)	Weight (kg)
KTV2.75	50	3	Direct-on-Line	0.75	15.0/16.0	0.32	12.5
	2				- /52.5	85	
KTV2-15	50	3	Direct-on-Line	1.5	20.0/21.0	0.42	21
	2				- /69	111	
KTV2-22	50	3	Direct-on-Line	2.2	24.0/26.0	0.52/0.495	23.0
	2				- /85	- /131	
KTV2-37H	50	3	Direct-on-Line	3.7	33.8/35.0	0.50/0.48	36
	2				- /115	- /127	
KTV2-37	80	3	Direct-on-Line	3.7	26.5/28.5	0.83/0.82	36
	3				- /94	- /217	
KTV3-55 *	80	3	Direct-on-Line	5.5	35.0/37.0	0.98/0.87	47
	3				- /121	- /230	
NK3-15	50(80)	1	Capacitor-Start	1.5	20.0/21.0	0.42	29
	2(3)				- /69	111	
NK4-22	50(80)	1	Capacitor-Start Capacitor-Run	2.2	24.0/26.0	0.525/0.495	29
	2(3)				- /85	- /131	
NK4-22L	80	1	Capacitor-Start Capacitor-Run	2.2	18/19	0.8/0.8	36
	3				- /62	- /211	

\* USA market: KTV2-55

**Note:** The weight (mass) given above is the operating weight of the pump itself, not including the cable.

## ■ Specifications - Automatic Pumps (50/60Hz)

Model	Discharge Bore (mm) (inch)	Phase	Starting Method	Output (kW)	Max. Total Head (m) (feet)	Max. Flow Rate (m <sup>3</sup> /min) (GPM)	Weight (kg)
KTVE2.75	50	3	Direct-on-Line	0.75	15.0/16.0	0.32	13.3
	2				- /52.5	85	
KTVE21.5	50	3	Direct-on-Line	1.5	20.0/21.0	0.42	22
	2				- /69	111	
KTVE22.2	50	3	Direct-on-Line	2.2	24.0/26.0	0.52/0.495	25
	2				- /85	- /131	
KTVE33.7	80	3	Direct-on-Line	3.7	26.5/28.5	0.83/0.82	40
	3				- /94	- /217	
KTVE35.5	80	3	Direct-on-Line	5.5	35.0/37.0	0.98/0.87	52
	3				- /121	- /230	

**Note:** The weight (mass) given above is the operating weight of the pump itself, not including the cable.

## 4 INSTALLATION

### ⚠ CAUTION

- Do not use this pump in liquids other than water, such as oil, salt water, or organic solvents.
- Use with a power supply voltage tolerance within  $\pm 5\%$  of the rated voltage.
- Do not use in water temperatures outside the range of 0 ~ 40°C, which can lead to failure, electrical leakage or shock.
- Do not use in the vicinity of explosive or flammable materials.
- Use only in fully assembled state.

**Note:** Consult your local dealer or Tsurumi representative before using with any liquids other than those indicated in this document.

### Maximum allowable water pressure

### ⚠ CAUTION

Do not use at greater than the water pressure shown below, which can damage the pump resulting in electrical leakage and electrical shock.

Model	Maximum allowable water pressure
KTV(E)2.75	0.2 MPa (2 kgf/cm <sup>2</sup> ) - discharge pressure used
All other models	0.5 MPa (5 kgf/cm <sup>2</sup> ) - discharge pressure used

## Preparing for installation

Before installing the pump at a work site, you will need to have the following tools and instruments ready:

- Insulation resistance tester
- AC voltmeter
- AC ammeter (clamp-on type)
- Bolt and nut tighteners
- Power supply connection tools (screwdriver or box wrench)

**Note:** Please read also the instructions that come with each of the test instruments.

## Checks to make before installation

Use the megohmmeter to measure the motor insulation resistance between the cabtyre cable plug tips and ground lead (Green or Green/Yellow).

■ Insulation resistance reference value =  $20M\Omega$  min.

**Note:** The insulation reference value of  $20M\Omega$  min. is based on a new or repaired pump. For reference value of a pump that has already been installed, refer to "7. Maintenance and Inspection" on page 16 of this manual.

## Automatic Pumps

Bundle each core of the cabtyre cable (Red, White and Black, or Brown, Grey and Black), then measure and check the insulation resistance between the ground wire (Green or Green/Yellow) with an insulation resistance tester.

**Note:** In case of measuring between each core of the cabtyre cable and ground wire, it may not measure correctly because of the characteristic.

■ Insulation resistance reference value =  $20M\Omega$  or more

**Note:** The insulation reference value of  $20M\Omega$  min. is based on a new or repaired pump. For reference value of a pump that has already been installed, refer to "7. Maintenance and Inspection" on page 16 of this manual.

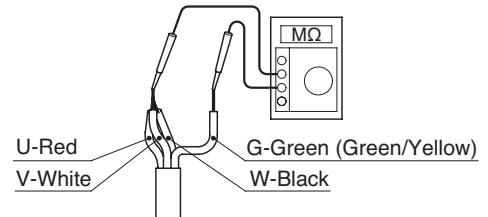

## CAUTION

Do not measure the insulation resistance with an insulation resistance tester for following parts. It may cause control circuit troubles.

- (1) Between the electrode and the pump body

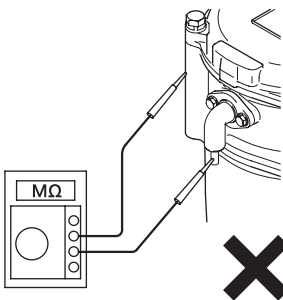

- (2) Between the electrode and each lead wire

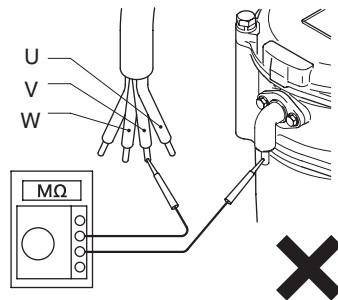

## CAUTION

Do not lift or suspend by the electrode level sensor. It may cause current leakage, electrical shock or fire.

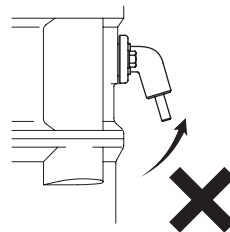

## Precautions in installation



### WARNING

- When installing the pump, pay close attention to its center of gravity and weight. If it is not lowered into place correctly, it may fall and be damaged or cause injury.
- When transporting the pump by hand, be sure to employ manpower commensurate with the weight of the pump. To avoid back injury when lifting the pump, bend the knees to pick it up rather than bending your back only.



### CAUTION

Do not under any circumstances install or move the pump by suspending it from the cabtyre cable. The cable may be damaged, causing electrical leakage, shock, or fire.

- (1) Attach the hose to the hose coupling as far as it will go, then fasten it securely with the hose band.

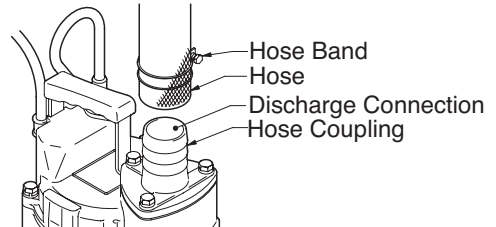

- (2) Avoid dropping the pump or other strong impact. Lift the pump by holding it firmly with the hands or by attaching a rope or chain to the handle.

**Note:** On Cabtyre cable handling, see below *Electrical Wiring*.

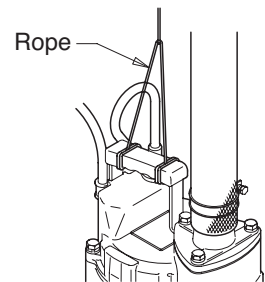

- (3) Install the pump in a location with sufficient water level, where water collects readily.

**Note:** The "Operating water level" chart on page 13 shows the water level necessary for operation. The tip of the hose (discharge end) should be located higher than the water surface. If the end of the hose is submerged, water may flow back to the pump when the pump is stopped; and if the hose end is lower than the water surface, water may overflow when the pump is turned off.

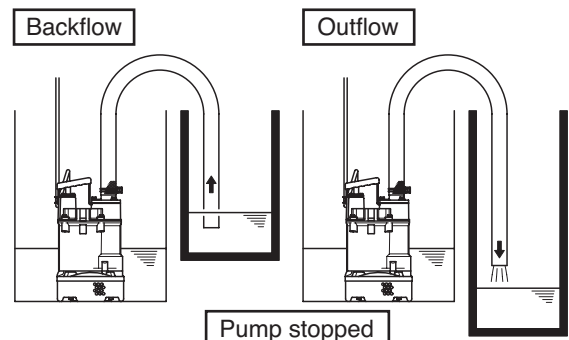

- (4) The hose should be run as straight as possible, since excessive bending will hinder the water flow, preventing sufficient lift, and can even cause the hose to become clogged with earth. If the hose is crimped near the pump, air can become trapped in the pump and cause idle running.



### CAUTION

- If large quantities of earth are sucked up, damage resulting from abrasion in the pump can lead to electrical leakage and shock.
- When the pump is installed at a work site, make sure the hose is connected in such a way as to ensure proper drainage. Otherwise water may leak out and cause damage to surrounding walls or flooring, or to equipment.

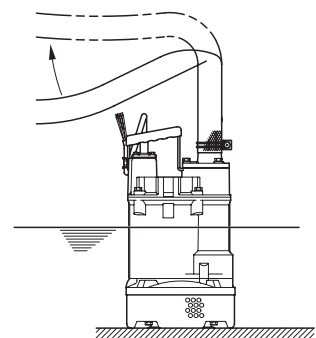

- (5) Use the pump in the upright position. To prevent the pump from becoming submerged in mud, mount it on a block or other firm base if necessary.



### CAUTION

Pay attention that the electrode level sensor shall not be splashed. It may cause a malfunction.

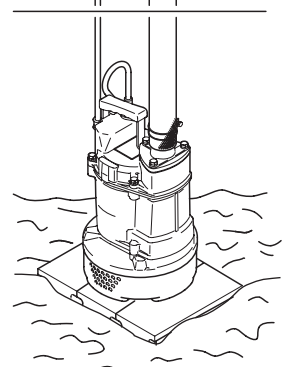

# 5 ELECTRICAL WIRING

## Performing electrical wiring



### WARNING

- Electrical wiring should be performed by a qualified person in accord with all applicable local regulations. Failure to observe this precaution not only risks breaking the law but is extremely dangerous.
- Incorrect wiring can lead to electrical leakage, electrical shock or fire.
- Absolutely provide a dedicated earth leakage circuit breaker and a thermal overload relay suitable for the pump (available on the market). Failure to follow this warning can cause electrical shock or explosion when the product fails or an electrical leakage occurs.

Operate well within the capacity of the power supply and wiring.

## Grounding



### WARNING

Do not use the pump without first grounding it properly. Failure to ground it can lead to electrical shock from an electrical leak or pump malfunction.



### CAUTION

Do not attach the grounding wire to a gas pipe, water pipe, lightning arrestor or telephone grounding wire. Improper grounding can result in electrical shock.

## Cabtyre cable



### CAUTION

- If it is necessary to extend the cabtyre cable, use a core size equal to or larger than the original. This is necessary not only for avoiding a performance drop, but to prevent cable overheating which can result in fire, electrical leakage or electrical shock.
- If a cable with cut insulation or other damage is submerged in the water, there is a danger of water seeping into the motor causing a short. This may result in damage to the pump, electrical leakage, electrical shock, or fire.
- Be careful not to let the cabtyre cable be cut or become twisted. This may result in damage to the pump, electrical leakage, electrical shock, or fire.
- If it is necessary to submerge the connection leads of the cabtyre cable in water, first seal the leads completely in a molded protective sleeve, to prevent electrical leakage, electrical shock, or fire.

Do not allow the cabtyre cable leads to become wet.

Make sure the cable does not become excessively bent or twisted, and does not rub against a structure in a way that might damage it.

## Connecting the cabtyre cable



### WARNING

Before connecting leads to the terminals, make certain the power supply is turned off (circuit breaker, etc.), to avoid electrical shock, shorting, or unexpected starting of the pump, leading to injury.



### CAUTION

Do not use the pump if the cabtyre cable is worn or damaged, which can result in electric shock, shorting, or fire.

Connect the leads of cabtyre cable to the control panel terminals as shown in the diagram, being careful not to let the leads become twisted together.

Single-phase models

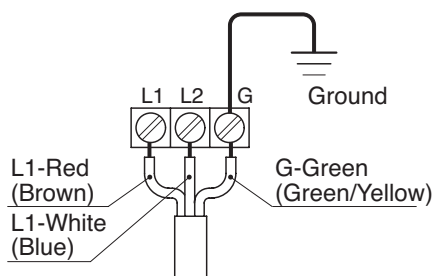

Three-phase models

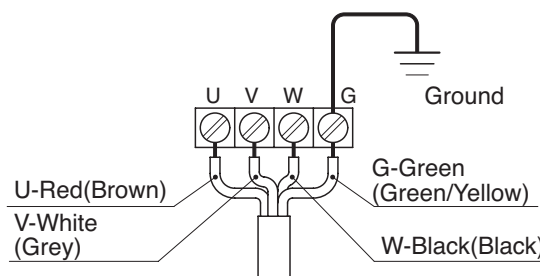

# Electrical circuit diagrams

Direct on line

KTV models

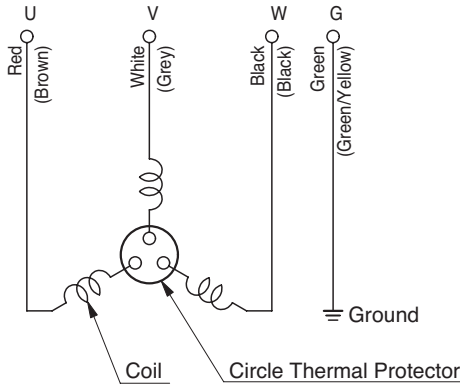

KTVE  
0.75kW models

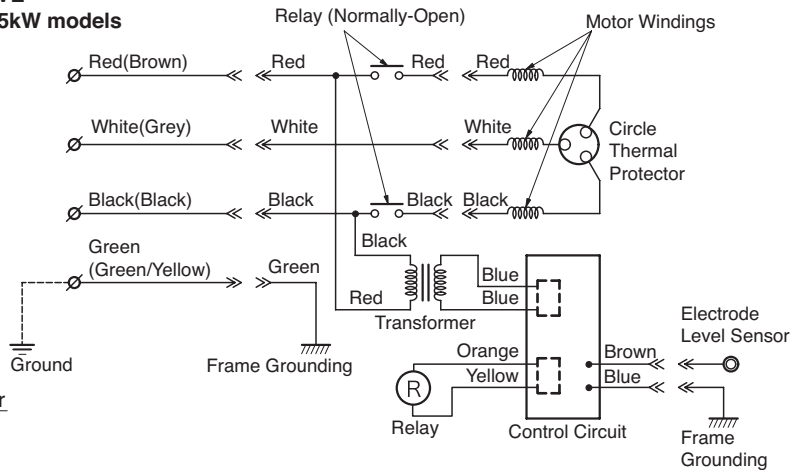

KTVE  
1.5~5.5kW models

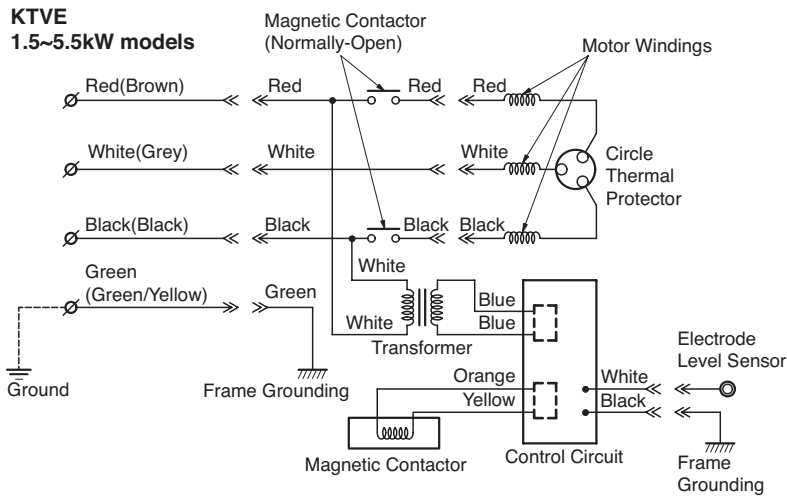

NK3-15 Capacitor-Start models, Single-phase motor  
(110V-50/60Hz)

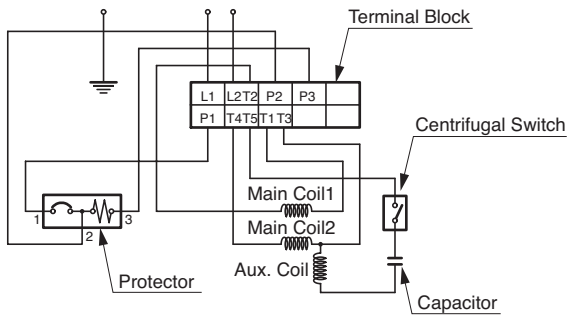

NK3-15 Capacitor-Start models, Single-phase motor  
(220V-50/60Hz)

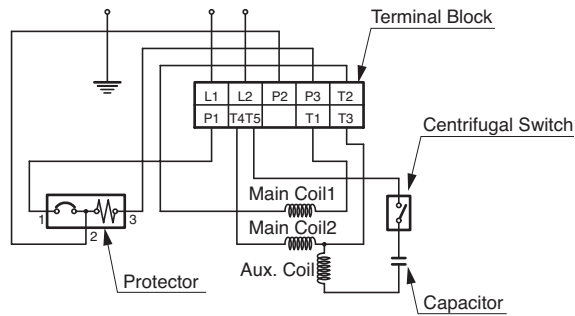

NK3-15 Capacitor-Start models, Single-phase motor  
(220/230/240V-50Hz)

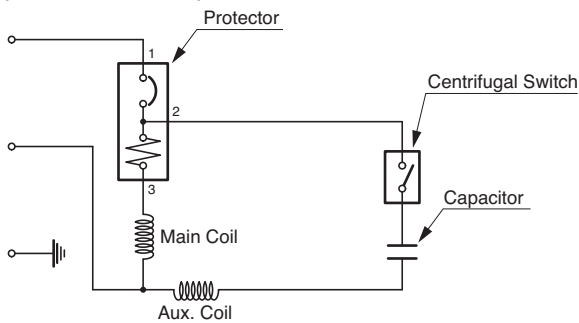

NK4-22(L) Capacitor-Start and Capacitor-Run models,  
Single-phase motor

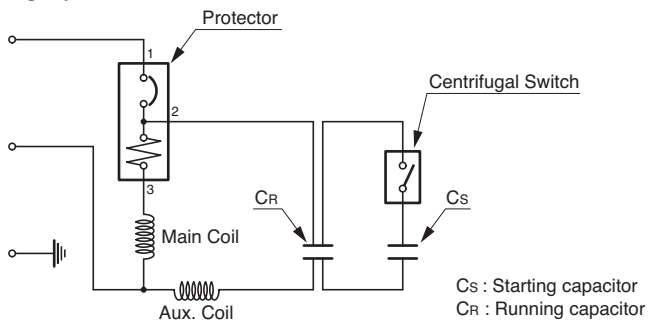

## 6 OPERATION

### Before starting

- (1) Make sure once again that the product is of the correct voltage and frequency rating.

**CAUTION** Using the product at other than rated voltage and frequency will not only lower its performance but may damage the product.

**Note:** Confirm the rated voltage and frequency on the model name plate.

- (2) Confirm the wiring, supply voltage, circuit breaker capacity, and motor insulation resistance.

Reference insulation resistance = 20 MΩ or greater

**Note:** The reference insulation resistance (20MΩ or greater) is the value when the pump is new or has been repaired. For the reference value after installation, see below at section "7.Maintenance and Inspection "

- (3) The setting on the circuit breaker or other overload protector should be made in accord with the rated current of the pump.

**Note:** See the model name plate on the pump for its rated current.

- (4) When powering the pump with a generator, do not share the generator with other equipment.

### Test operation

**WARNING**

- Never operate the pump while it is suspended in the air. The recoil may result in injury or other major accident.
- Never start the pump when people are standing next to it. An electrical leak can result in electrical shock.

- (1) Run the pump for a short time(1~2 seconds) to check the direction of rotation. The rotation is correct if the pump recoil direction is counter-clockwise.

**CAUTION** Always perform the rotation check in air, not while the pump is submersed. Running the pump in reverse direction while submersed may damage the pump, resulting in electrical leakage or electrical shock.

- (2) If the direction is reversed, correct it using the countermeasure shown below.

**WARNING** Before changing the connections to correct the rotation, be sure to turn off the power supply (circuit breaker), and make sure the impeller has stopped completely, to avoid electrical shock or shorting.

#### COUNTERMEASURE

(Direct-on-line start models):  
Interchange connections between any two of the three leads U, V, or W.

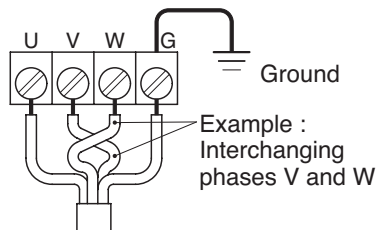

#### COUNTERMEASURE

(Star-delta start models):  
Interchange connections between any two of the three leads R, S, or T.

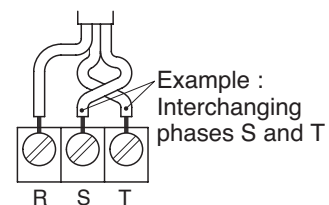

- (3) Run the pump for a short time (3~10minutes) and confirm the following.  
Using an ammeter(clamp-on type), measure the operating current at the U, V, and W phase leads on the terminal strip.

#### COUNTERMEASURE

If the operating current exceeds the rated value, pump motor overload may be a cause. Make sure the pump has been installed under proper conditions as described in the section on Installation.

Using an AC voltmeter(tester), measure voltage at the terminal strip.

■ Supply voltage tolerance : within  $\pm 5\%$  of rated voltage.



## COUNTERMEASURE

If the supply voltage is outside the variation, possible causes are the power supply capacity or an inadequate extension cable. Look again at Electrical Wiring and make sure the conditions are proper.

**CAUTION** In case of very excessive vibration, unusual noise or odor, turn off the power immediately and consult with your nearest dealer or Tsurumi representative. Continuing to operate the pump under abnormal conditions may result in electrical shock, fire, or electrical leakage.

(4) If the test operation turns up no problems, continue with full operation.

## Operation

**WARNING**

- The pump may become very hot during operation. Be careful not to contact the pump accidentally to avoid being burned.
- To avoid serious injury, do not insert a finger or any other object in the pump inlet holes.
- When the pump is not used for an extended period, be sure to turn off the power (circuit breaker, etc.). Deterioration of the insulation may lead to electrical leakage, electrical shock, or fire.
- In case of a power outage, turn off the power to the pump to avoid having it start unexpectedly when the power is restored, presenting serious danger to people in the vicinity.

Pay careful attention to the water level while the pump is operating. Dry operation may cause the pump to malfunction.

**Note:** See below, "Operating water level" for the water level necessary for operation.

## Operation water level

**CAUTION** Do not operate the pump below the C.W.L. (Continuous Running Water Level). Failure to observe this condition may result in damage to the pump, electrical leakage or electrical shock.

The table shows the C.W.L. for different output classes. Be careful not to allow the water level to drop below the applicable limit.

Applicable Model	C.W.L. (mm)
KTV2-75	65
KTV2-15	80
KTV2-22	80
KTV2-37H	90
KTV2-37	90
KTV3-55 *	90
NK3-15	80
NK4-22	80
NK4-22L	105

\* USA market: KTV2-55

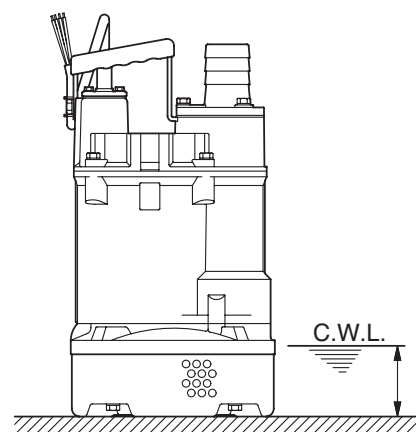

## In the Case of Automatic Pumps

### Starting of a pump

The pump starts when the current (micro current) continuously flows between a conductive part (Shaft, Bolt, etc.) and the electrode level sensor for more than one (1) second.

**Note:** The electrode may not detect the water surface under conditions such as purified water or distilled water with which the current does not flow because of high specific resistance.

## ■ Starting Water Level

The water level is decided by the distance between the tip of the electrode level sensor and the sump bottom. If you want to set the starting water level lower, please set as following instruction.

- (1) Fit an extension electrode (optional accessory) to the Electrode Level Sensor of the pump. (The extension electrode is available as an optional accessory.)
- (2) The water level is the distance between the sump bottom and the end.
- (3) Please adjust the water level to the lowest starting level or upper.

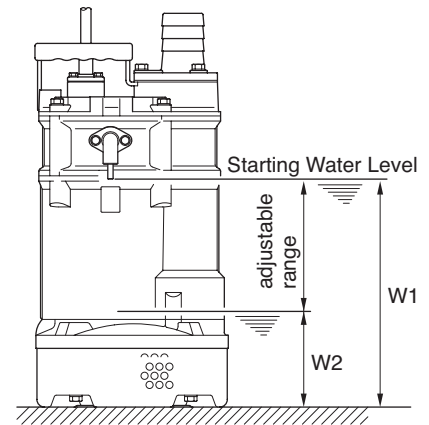

**Note:**

- If you set the water level lower than the lowest starting level, it may not operate correctly because of an air lock and so on.
- Extension Electrode should not touch the pump body.
- In case of starting the unit under non-submerged condition during a trial operation, please short-circuit for more than one (1) second the electrode and the conductive part (bolt, etc.) with a conductive item (lead wire, etc.), and start forcibly.
- You will not get an electric shock if you touch the electrode during power on, however it may cause a wrong operation.

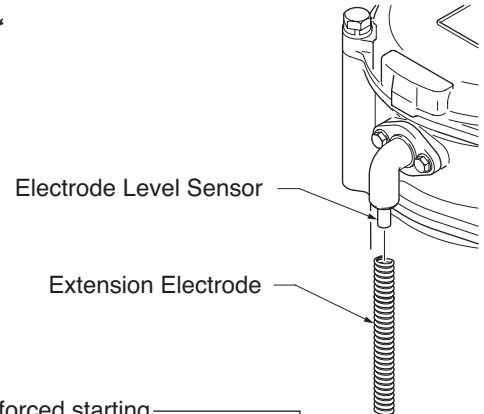

Unit : mm

Pump Model	W1	W2
KTVE2.75	239	149
KTVE21.5	266	176
KTVE22.2	266	176
KTVE33.7	327	237
KTVE35.5	357	267

W1 : Starting Water Level  
(Default setting value)

W2 : The Lowest Starting Level  
(Continuous Running Water Level)  
in case of using an Extension Stick

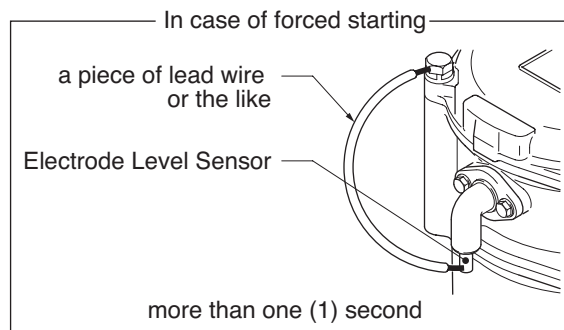

## Motor protection system



### WARNING

During inspections or repairs, always be sure to turn off the power. Sudden unexpected starting of the pump can cause electrical shock, shorting, or serious injury.



### CAUTION

- Always determine the cause of the problem and resolve it before resuming operation. Simply repeating cycles of stopping and restarting will end up damaging the pump.
- Do not continue operation at very low water level, or while the strainer stand is clogged with debris. Not only will performance suffer, but such conditions may cause noise, heavy vibration, and malfunctioning.

#### Circle Thermal Protector

If a current overload or overheating occurs under the symptoms given below, the motor will stop automatically to protect the motor regardless of the water level at the time of operation.

In this type of motor protector, the motor will automatically restart after cooling down. If the motor is stopped by protector tripping, turn off the power supply first, and disconnect the cables from the power terminals. After this, make sure to eliminate the cause of the problem, such as the following:

- Extreme fluctuation of power supply voltage
- Pump operated under overload condition
- Pump operated at open phase or binding condition









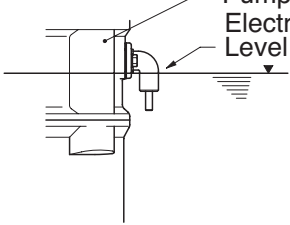
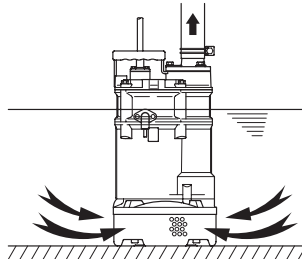
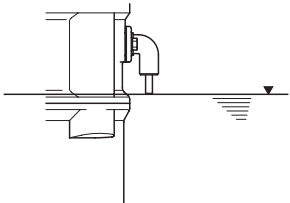

### WARNING

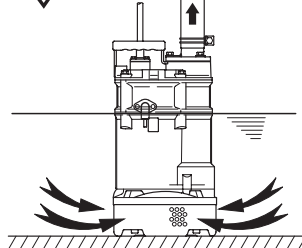
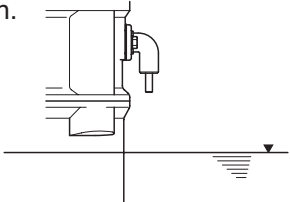
If repair or maintenance is attempted with cables connected to power supply, unintended automatic restarting of the motor may cause human injury.

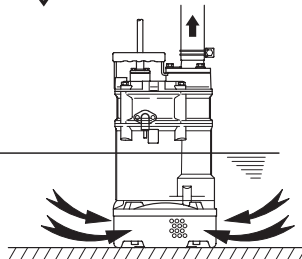
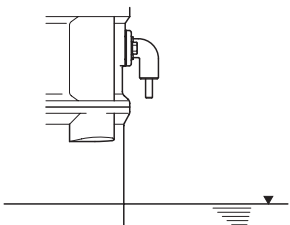
## Operating Principle of the Automatic Pumps

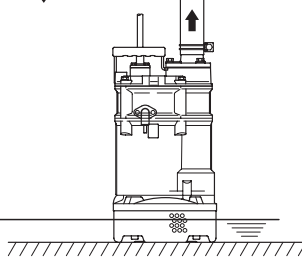
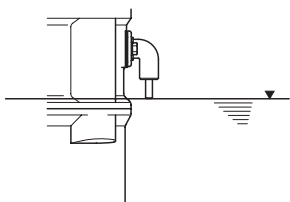
This explains the control form by a combination of an electrode and a timer function. Please understand the performance of this pump and apply it.

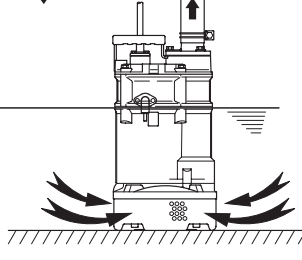
Electrode Level Sensor	Pump	Water Level	Condition
<p>Electrode level sensor will submerge and the pump will operate by the current.</p>  <p>(Detection Time : more than one (1) second)</p>	Start operation (Drainage)	Drop	<p>[Switch on]</p> 
<p>When the water level drops and detaches the electrode from the water surface, a timer will start. Pump keeps draining.</p>  <p>(Released the Electrode → The timer is on)</p>	Operation (Drainage)	Drop	 
<p>The operation time with the timer will be approx. 1 minute. * If the water surface touches to the electrode for more than one (1) second within 1 minute, the pump operates continuously even though the timer is on.</p> 	Operation (Drainage)	Drop	 
<p>After 1 minute, the pump will stop. * If the water is drained within 1 minute, the pump continues to run in snore mode until the set time comes.</p> 	Stop	Rise	 
<p>When the water level rises and the water surface touches to the electrode again for more than one (1) second, pump will restart.</p>  <p>(Detection Time : more than one (1) second)</p>	Start operation (Drainage)	Drop	 

# 7 MAINTENANCE AND INSPECTION

Regular maintenance and inspections are a necessity for continued efficient functioning of the pump. If any abnormal conditions are noticed, refer to the section "9.Troubleshooting" and take corrective measures immediately. It is recommended that a spare pump be kept ready in case of any problems.

## Prior to inspection



**WARNING** Detach the cabtyre cable from the receptacle or terminals, after making certain the power supply (circuit breaker, etc.) is turned off. Failure to follow this precaution may result in a serious accident from electrical shock or unexpected starting of the pump motor.

- (1) Washing the pump  
Remove accumulated matter from the surface of the pump and wash it with clean water. Take special care to remove any debris from the impeller.
- (2) Inspecting the pump exterior  
Look for any peeling or chipped paint, and make sure the nuts and bolts are fastened tightly. Any cracks in the surface should be repaired by cleaning that area, drying it and then applying a touchup coating.

**Note:** *Touchup is not supplied. Note that some kinds of damage or looseness may require that the unit be disassembled for repairs. Please consult with your nearest dealer or Tsurumi representative.*

## Regular Inspection

Frequency	Inspection Items
Daily	<ul style="list-style-type: none"> <li>■ Measuring the operating current ● To be below the rated current</li> <li>■ Measuring the power voltage ● Power supply voltage tolerance = within <math>\pm 5\%</math> of the rated voltage</li> </ul>
Monthly	<ul style="list-style-type: none"> <li>■ Measure insulation resistance ● Reference insulation resistance = 1M<math>\Omega</math> or greater <i>Note: If the insulation resistance has become notably lower than the previous inspection, an inspection of the motor will be necessary.</i></li> <li>■ Pump inspection ● A noticeable drop in performance may indicate wear in the impeller etc., or else clogging of the strainer stand, etc. Remove the clogged debris, and replace any worn parts.</li> <li>■ Inspecting the electrode ● Clean the electrode periodically with an abrasive paper or the like.</li> </ul>
Half-yearly	<ul style="list-style-type: none"> <li>■ Oil inspection (models with 0.75kW) ● Check the oil every six months or after 1,000 hours of use, whichever comes first.</li> <li>■ Oil inspection (models with 1.5kW or above power output) ● Check the oil every six months or after 3,000 hours of use, whichever comes first.</li> <li>■ Inspection of lifting wire rope or chain ● Replace if damage, corrosion, or wear has occurred to the wire rope or the chain. Remove if foreign object is attaching to it.</li> </ul>
Yearly	<ul style="list-style-type: none"> <li>■ Change oil (models with 0.75kW) ● Change the oil every 12 months or after 2,000 hours of use, whichever comes first. Designated oil : Turbine oil VG32 <i>Note: See below for details of oil inspection and oil change.</i></li> <li>■ Change oil (models with 1.5kW or above power output) ● Change the oil every 12 months or after 6,000 hours of use, whichever comes first. Designated oil : Turbine oil VG32 <i>Note: See below for details of oil inspection and oil change.</i></li> <li>■ Change mechanical seal <i>Note: Specialized know-how is required for inspecting and replacing the mechanical seal. Consult with your nearest dealer or Tsurumi representative.</i></li> </ul>
Every 2 to 5 years	<ul style="list-style-type: none"> <li>■ Overhaul ● This should be carried out even if there are no problems with the pump. The frequency depends on how continuously the pump is in use. <i>Note: Consult with your nearest dealer or Tsurumi representative regarding overhauls.</i></li> </ul>

## Storage

When the pump is out of use for an extended period, wash it and dry it thoroughly, then store it indoors. If the pump is left in the water, it should be run at a minimum of once a week to prevent it from locking up.

**Note:** *Always run a test operation before putting the pump back into service.*

## Oil inspection and Oil change

### Inspecting oil

Remove the oil plug (hex. bolt) and tilt the pump to drain a small amount of oil. If the oil is milky white or has water mixed in with it, the mechanical seal may be faulty. In this case the pump will need to be disassembled and repaired.

### Replacing oil

Remove the oil plug and drain all the oil, then replace it with the specified amount.

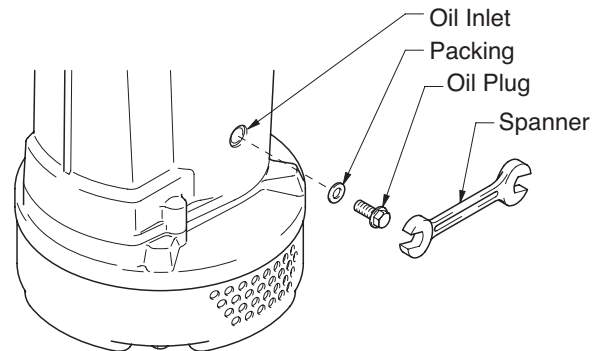

**Note:** *Worn oil and other waste products should be disposed of by a qualified agent, in accord with applicable laws. The oil plug packing should be replaced each time the oil is inspected or changed.*

Specified Oil : Turbine Oil VG32 (non-additive) Unit : ml

Applicable Model	Specified Volume
KTV2.75, KTVE2.75	150
KTV2-15, KTV2-22, KTVE21.5, KTVE22.2	270
KTV2-37H, KTV2-37, KTVE33.7	400
KTV3-55 *, KTVE35.5	680
NK3-15, NK4-22(L)	270

\* USA market: KTV2-55

## Replacement Parts

The table lists the parts that need to be replaced periodically. Replace these using the recommended frequency as a guideline.

Part	Replacement frequency
Mechanical Seal	When oil in oil compartment becomes milky.
Lubricant ; Turbine Oil VG32 (non-additive)	Every 6,000 hours or 12 month, whichever comes first.
Packing, O-Ring	Each time pump is disassembled or inspected.
V-Ring	When ring is worn, and each time pump is disassembled or inspected
Shaft sleeve	When it becomes worn

 **WARNING**

- Before disassembling the pump, first detach the Cabtyre Cable from the receptacle or terminals, after making certain the power supply (circuit breaker, etc.) is turned off. To avoid electrical shock, do not work with wet hands. Never check the operation of any parts (impeller rotation, etc.) by turning on the power while the unit is partially assembled. Failure to observe these precautions may result in serious accident.
- Do not disassemble or repair any parts other than those designated here. If repairs are necessary in any other than the designated parts, consult with your nearest dealer or Tsurumi representative. Improper repairs can result in electrical leakage, electrical shock, fire, or water leaks.
- After reassembly, always perform a test operation before resuming use of the pump. Improper assembly will cause the pump to malfunction, resulting in electrical shock or water leaks.

The procedure for disassembly and reassembly is shown here to the extent necessary for impeller replacement. A specialized environment and facilities are necessary for work in the mechanical seal and motor parts. Contact your nearest dealer or Tsurumi representative in the event such repairs are necessary.

 **Disassembly**

**Note:** *Remove the oil prior to disassembly.*

- (1) Removing the Strainer Stand, Fixing Plate and Pump Casing  
Remove the Strainer Stand Hex. Bolts and Plain Washers, then remove the Strainer Stand, Fixing Plate and Pump Casing from the pump.
- (2) Removing the Impeller  
With a socket wrench or other tool, loosen the Impeller Nut and Hex. Nuts, remove the Plain Washer and key, then remove the Impeller, Shaft Sleeve and V-Ring from the Shaft.
- (3) Removing the Rear Liner  
Remove the Rear Liner from the Oil Casing.



**WARNING** A worn Impeller may have sharp edges that can cause injury, and should be handled with care.

# Disassembly Diagram

## Example 1 - Model KTV2-22

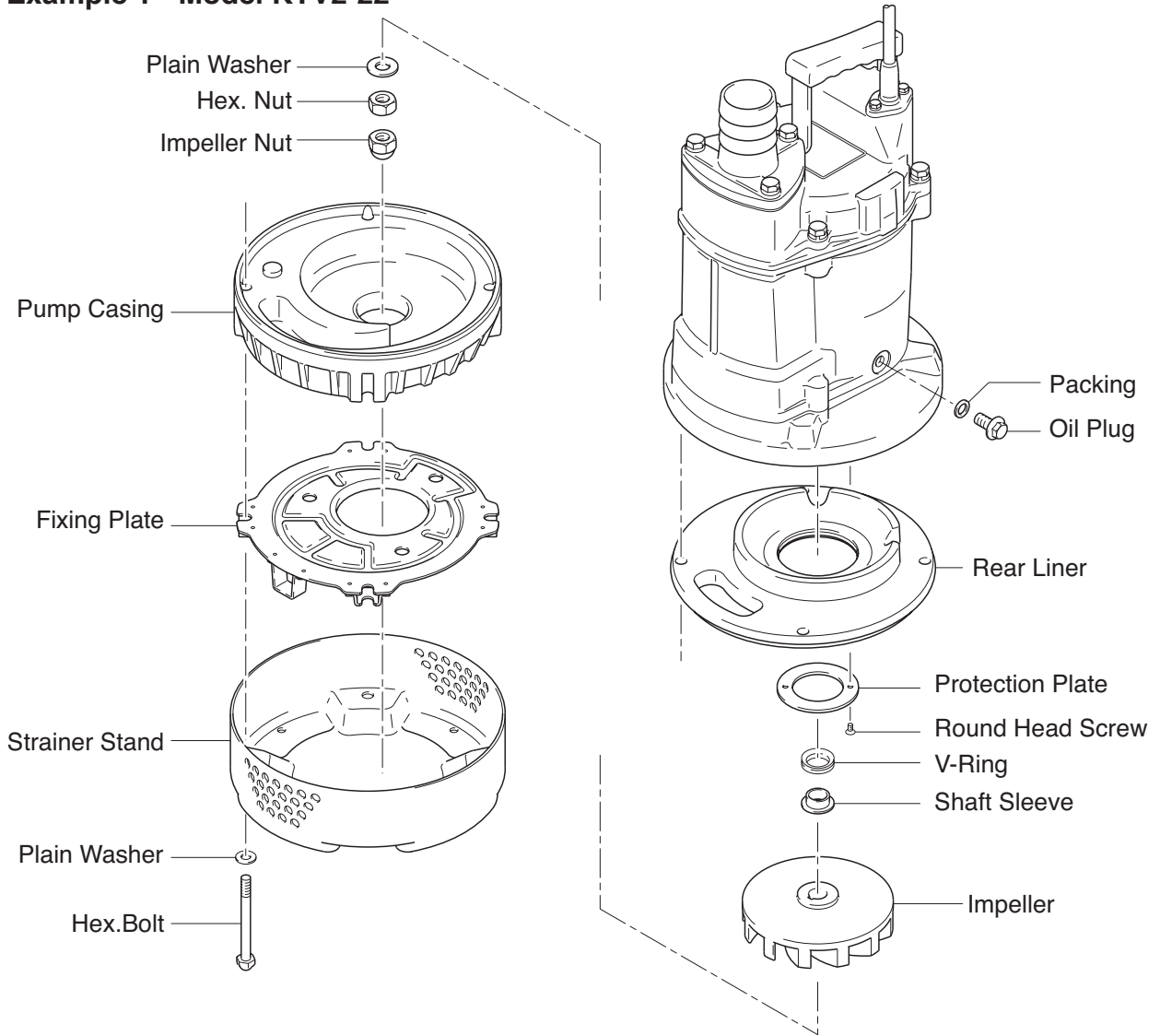

## ■ Example 2 - Model NK4-22

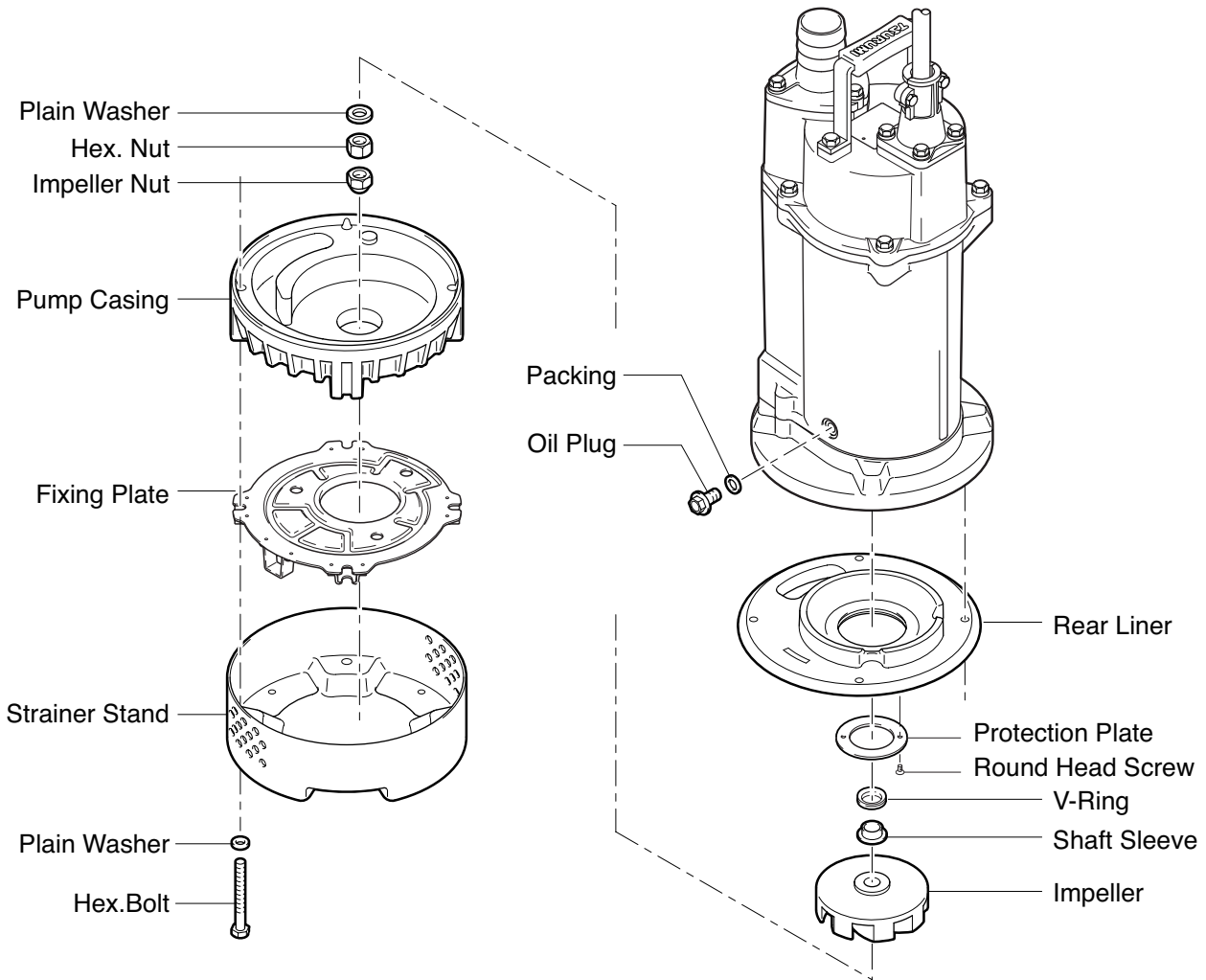

**Note:** The above exploded views are for model KTV2-22 and NK3-22. Other models may differ slightly in shape and construction.

### ■ Reassembly

- (1) Reassembly can be performed by reversing the steps for disassembly, paying attention to the following precautions.

**Note:**

- After assembling the pump, do not forget to fill it with oil up to the required amount.
- Replace the Packing and O-Ring each time this operation is performed. Replace any other parts worn or damaged as well.

**Note:** Mount the V-Ring on the outside of the Shaft Sleeve as shown in right. Never put oil on the mating surface between the Shaft Sleeve and the V-Ring.

- (2) After installing the Impeller, and after completing the reassembly, check to make sure that the impeller rotates smoothly and that it does not rub against any part of the Pump Casing.

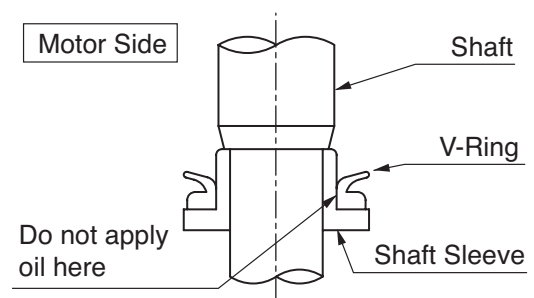



# 9 TROUBLESHOOTING

**⚠ WARNING** Always turn off the power before inspecting the pump. Failure to observe this precaution can result in serious accident.

Before ordering repairs, carefully read through this instruction manual, then repeat the inspection. If the problem remains, contact your nearest dealer or Tsurumi representative.

Problem	Possible causes	Countermeasure
Pump will not start	(1)Power is off. (2)Cabtyre cable is cut or not connected properly. (3)Impeller is clogged. (4)Obstructed conductivity. (5)Short circuit between electrode and the body by fouling object. (6)Being subjected to nearby electric apparatus.	(1)Turn power on. (2)Repair/replace the cable or fix the connection. (3)Inspect the pump and remove any debris. (4)Clean the electrode. (5)Remove the object that causes short circuit. (6)Relocate if it is found to be true.
Pump stops soon after starting (Motor protector operates)	(1)Impeller is clogged. (2)Low voltage. (3)Wrong power frequency. (4)Extended operation with a clogged strainer stand. (5)Faulty motor (burning, water infiltration, etc.). (6)Motor protection system was triggered.	(1)Remove debris. (2)Provide the rated voltage, or make sure the cabtyre cable extension is the proper standard. (3)Check the name plate, and replace the pump. (4)Remove debris from the strainer stand. (5)Repair or replace the motor. (6)If the pump is to be used for heavy liquid or other high loads, upgrade impeller.
Poor pumping head or discharge capacity	(1)Worn out impeller or suction cover. (2)Sharply bent or clogged hose. (3)Strainer stand clogged or buried. (4)Motor direction is reversed. (5)Wrong power frequency.	(1)Repair or replace the worn parts. (2)Straighten out any sharp bends. Enclose the pump with a screen to keep away debris. (3)Remove debris from the strainer stand, or place a block under the pump. (4)Interchange power supply leads as per p.10. (5)Check the name plate, and replace the pump.
Heavy vibration or noise	(1)Damaged motor shaft.	(1>Contact dealer and replace motor.

The following information is required when ordering repairs or making other inquiries.

Product model	
Manufacturing number	
Purchase date	
Remarks	

## Disposal Product

Properly dispose of the product by disassembling it, presorting the contents, and sending them to the waste material treatment site.