



VANCS - SERIES - PU
(FRP) SEMI-VORTEX - SEWAGE & WASTE WATER PUMPS

SPECIFICATIONS

FEATURES

1. Semi-vortex , FRP (Fiberglass Reinforced Plastic), impeller passes solids and stringy material without clogging and increases wear resistance when pumpage contains abrasive particles.
2. Double inside mechanical seals with silicon carbide faces, running in an oil filled chamber and further protected by a lip seal, provides for the most durable seal design available.
3. Highly efficient, continuous duty, air filled, copper wound motor with class E, insulation minimizes the cost of operation.
4. Built in thermal & amperage sensing, protector prevents motor failure due to overloading, single phasing (in three phase units), or accidental run -dry conditions.

5. Double shielded, permanently lubricated, high temperature C3 ball bearings rated for a B-10 life of 60,000 hours, extends operational life.
6. Utilization of application appropriate FRP & stainless steel components increases corrosion resistance in a wide variety of applications.

APPLICATIONS

1. Residential, commercial, industrial sewage, effluent, wastewater and site drainage.
2. Chemical spill containment.
3. Decorative waterfalls, fountains and fish ponds.



SPECIFICATIONS

- Discharge Size
- Horsepower Range
- Performance Range Capacity
- Head
- Maximum water temperature
- Materials of Construction
 - Casing (upper)/(lower)
 - Impeller
 - Shaft
 - Motor Frame
 - Fasteners
- Mechanical Seal
 - Elastomers
- Impeller Type
- Solids Handling Capability
- Bearings
- Motor Nomenclature
 - Type, Speed, Hz.
 - Voltage, Phase
 - Insulation
- Accessories
- Operational Mode

STANDARD

- 2~3" N.P.T. (50 ~ 80mm)
- 1/5 ~ 5Hp. (.15 ~ 3.7 kW)
- 13.2 ~ 240.4 G.P.M. (.05 ~ .91 m³/min)
- 5.7 Ft. ~ 86.9 Ft. (1.75 ~ 26.50 m)
- 104° F. (40° C.)
- FRP (ABS + w/GF 20 or 30) / ABS
- FRP (PPO + w/GF 20 or 30)
- 304 Stainless Steel
- 304 Stainless Steel
- 304 Stainless Steel
- Silicon Carbide
- NBR (Nitril Buna Rubber)
- Semi-Vortex, solids handling.
- 1.38 -1.81" (35 - 46 mm)
- Pre-lubricated, Double Shielded
- Air Filled, 3600 Rpm, 60 Hz.
- 115 or 230 V., 1 Ph.,
- 208-220, 230, 460, or 575 V . 3 Ph.
- Class E
- Submersible Power Cable 32' (10 m)
- Manual

OPTIONS

- Length as Required
- Model A (Automatic), Model AW (Automatic Alternating)
- TOK (FRP) Slide rail system



VANCS - SERIES - PU

(FRP) SEMI-VORTEX - SEWAGE & WASTEWATER PUMPS

PERFORMANCE RANGE

GROUP PERFORMANCE RANGE

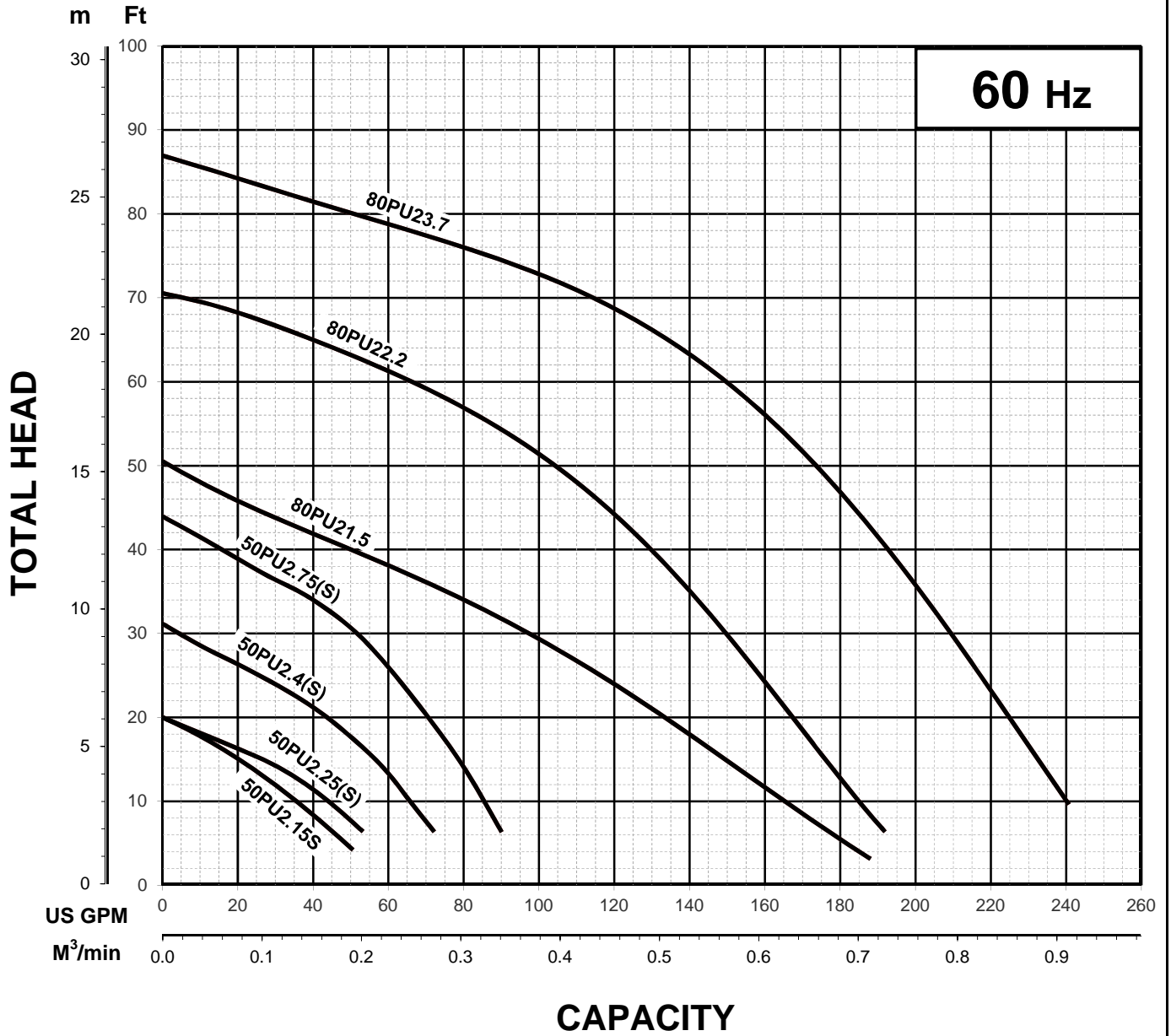

Note



VANCS - SERIES - PU
(FRP) SEMI-VORTEX - SEWAGE & WASTEWATER PUMPS

PERFORMANCE
CURVE

MODEL	BORE	HP	KW	RPM	SOLIDS DIA	LIQUID	SG.	VISCOSITY	TEMP.
50PU(A/W)2.4 -63	2" / 50mm	0.54	0.40	3395	1.38" / 35mm	Water	1.0	1.123 cSt.	60°F
PUMP TYPE	PHASE	VOLTAGE	AMPERAGE	HZ	STARTING METHOD	INS. CLASS			
Semi-Vortex - Sewage & Wastewater	3	208-220/460	2.1-2.0 / 0.95	60	Direct On Line	E			
CURVE No.	DATE	PHASE	VOLTAGE	AMPERAGE	HZ	STARTING METHOD	INS. CLASS		
-	-	-	-	-	-	-	-		

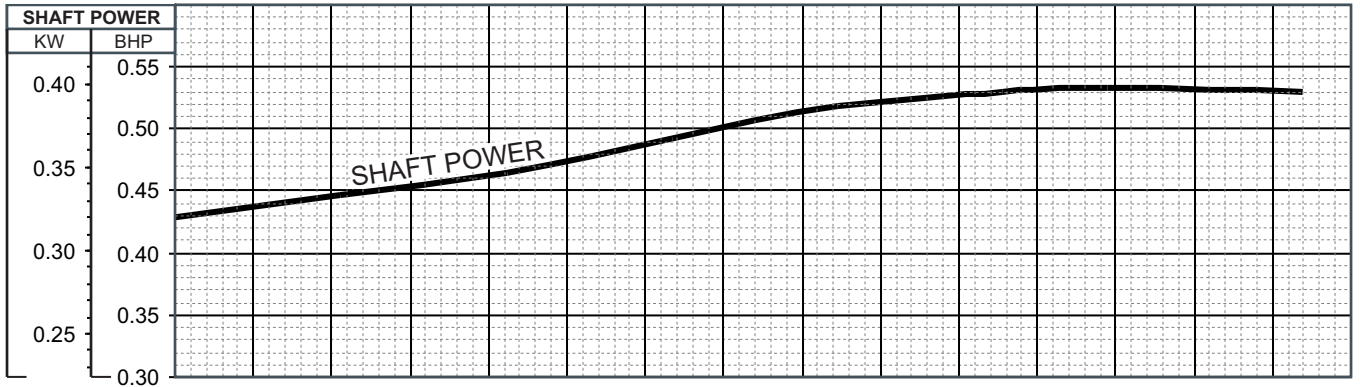
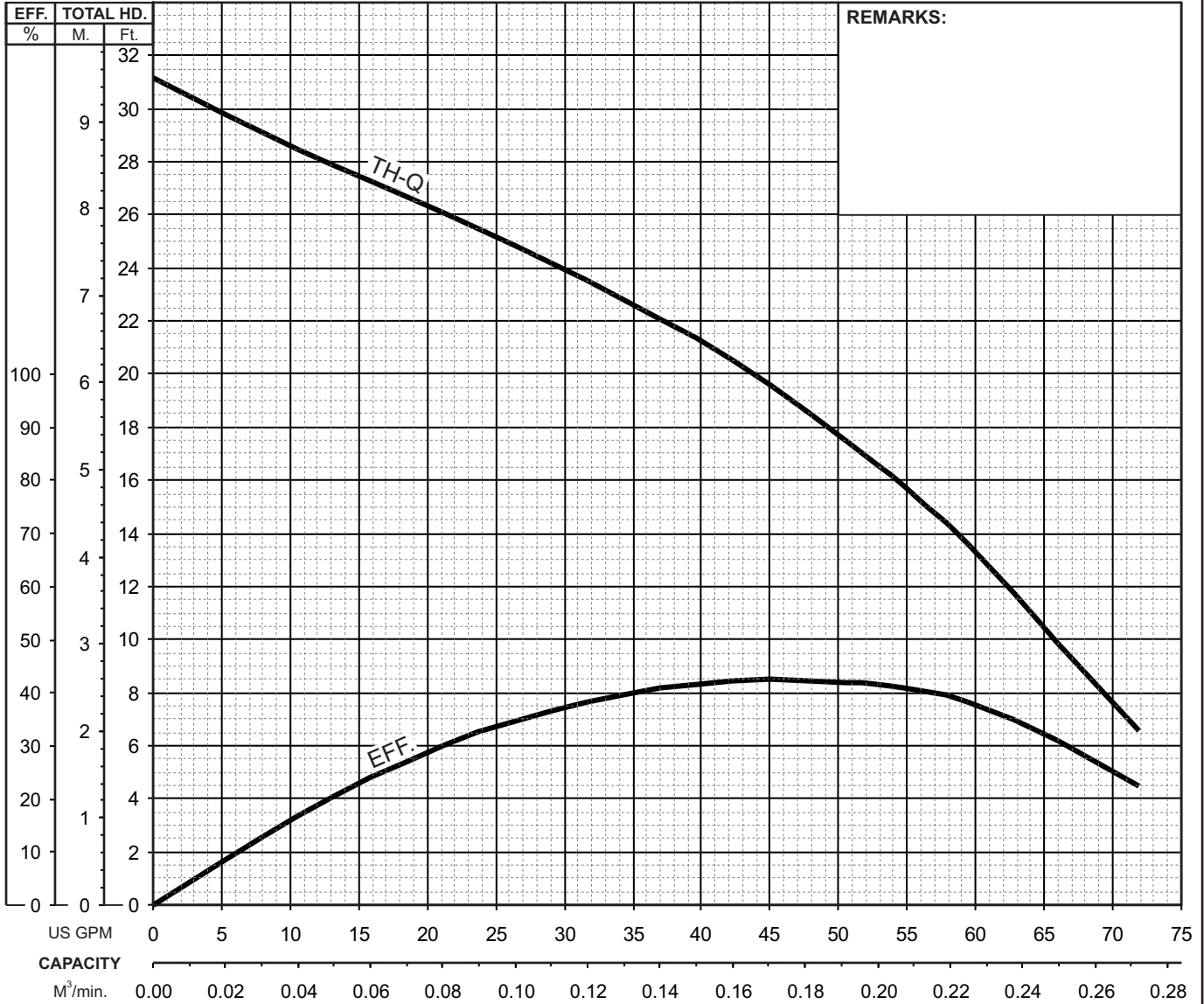



VANCS-SERIES - PU
(FRP) SEMI-VORTEX - SEWAGE & WASTEWATER PUMPS

DIMENSIONS

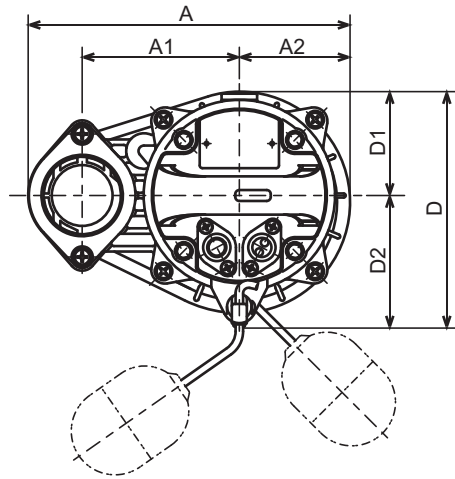

- 50PUA2.25S-63
- 50PUA2.25-63
- 50PUA2.4S-63
- 50PUA2.4-63
- 50PUA2.75S-63
- 50PUA2.75-63

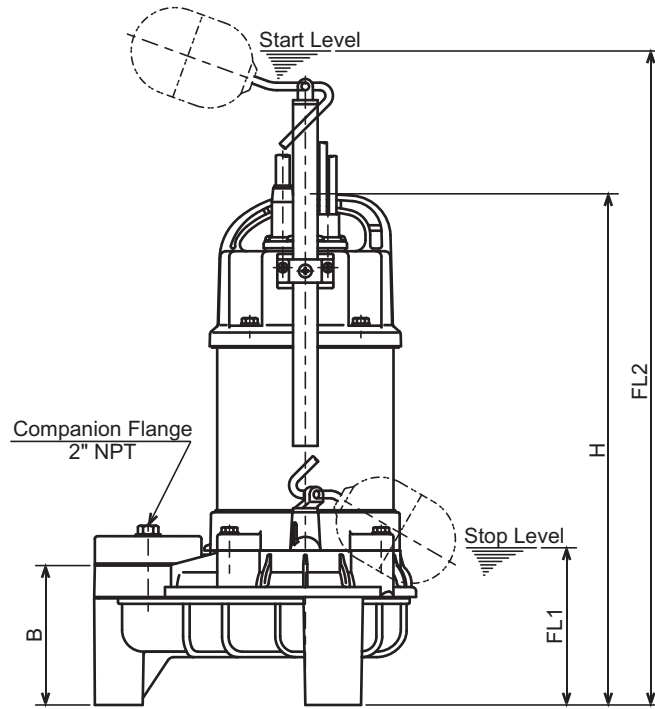

DIMENSIONS:USCS (In ch)

Model	HP	NOM. SIZE	Pump & Motor								Stop FL1	Start Max.FL2	Wt. (lbs.)
			A	A1	A2	B	D	D1	D2	H			
50PUA2.25S-63	1/3	2"	9 5/16	4 1/2	3 3/16	4	6 13/16	3	3 13/16	14 3/4	4 1/2	23 7/8	17.0
50PUA2.25-63	1/3	2"	9 5/16	4 1/2	3 3/16	4	6 13/16	3	3 13/16	14 5/16	4 1/2	23 1/2	14.8
50PUA2.4S-63	1/2	2"	9 5/16	4 1/2	3 3/16	4	6 13/16	3	3 13/16	14 3/4	4 1/2	23 7/8	17.0
50PUA2.4-63	1/2	2"	9 5/16	4 1/2	3 3/16	4	6 13/16	3	3 13/16	14 3/4	4 1/2	23 7/8	16.5
50PUA2.75S-63	1	2"	9 5/16	4 1/2	3 3/16	4	6 13/16	3	3 13/16	15 1/2	4 1/2	24 5/8	20.9
50PUA2.75-63	1	2"	9 5/16	4 1/2	3 3/16	4	6 13/16	3	3 13/16	15 1/4	4 1/2	24 1/2	19.6

DIMENSIONS:METRIC (mm)

Model	kW	NOM. SIZE	Pump & Motor								Stop FL1	Start Max.FL2	Wt. (kg)
			A	A1	A2	B	D	D1	D2	H			
50PUA2.25S-63	0.25	50	236	115	81	102	173	76	97	374	115	607	7.7
50PUA2.25-63	0.25	50	236	115	81	102	173	76	97	363	115	596	6.7
50PUA2.4S-63	0.40	50	236	115	81	102	173	76	97	374	115	607	7.7
50PUA2.4-63	0.40	50	236	115	81	102	173	76	97	374	115	607	7.5
50PUA2.75S-63	0.75	50	236	115	81	102	173	76	97	394	115	627	9.5
50PUA2.75-63	0.75	50	236	115	81	102	173	76	97	388	115	621	8.9



TSURUMI PUMP

VANCS - SERIES - PU
(FRP) SEMI-VORTEX - SEWAGE & WASTEWATER PUMPS

SECTIONAL VIEW

50PUA2.25-63
50PUA2.4-63

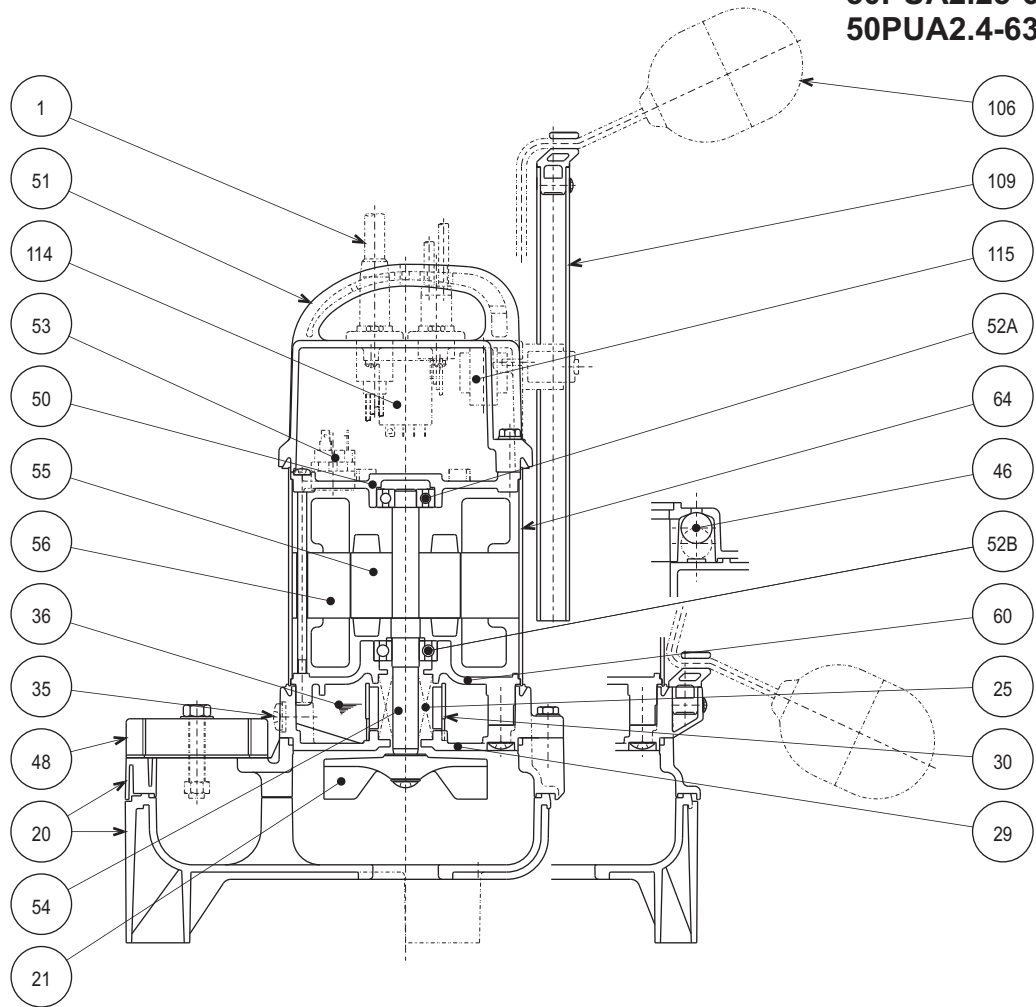

PART#	DESCRIPTION	MAIN MATERIAL / NOTE	RELATED ASTM, AISI CODE	RELATED EN CODE	QTY
1	Power Cable	PVC Sheath AWG16/4-32ft			1
20	Pump Casing	ABS Plastic w/GF20			1
21	Impeller	PPO Plastic w/GF20			1
25	Mechanical Seal	Silicon Carbide / W-14HL			1
29	Oil Casing	PPS Plastic w/(GF+MD)50			1
30	Oil Lifter	PBT Plastic			1
35	Oil Plug	Stainless Steel	S 30400	1.4301	1
36	Lubricant	White Mineral Oil ISO VG32			
46	Air Valve	Glass Ball			1
48	Companion Flange	PBT Plastic w/GF30 / NPT 2"			1
50	Motor Bracket	Aluminum Alloy Die Casting	B85 383.0	EN 1706 AC-46100	1
51	Motor Head Cover	PPS Plastic w/(GF+MD)50			1
52A	Upper Bearing	#6201ZZC3			1
52B	Lower Bearing	#6202ZZC3			1
53	Motor Protector				1
54	Shaft	Stainless Steel	S 30400	1.4301	1
55	Rotor				1
56	Stator				1
60	Bearing Housing	Aluminum Alloy Die Casting	B85 383.0	EN 1706 AC-46100	1
64	Motor Housing	Stainless Steel	S 30400	1.4301	1
106	Float Set	ABS Plastic			2
109	Float Support Pipe	PVC			1
114	Power Relay				1
115	Transformer				1

TSURUMI PUMP
VANCS - SERIES - PU
(FRP) SEMI-VORTEX - SEWAGE & WASTEWATER PUMPS
SAMPLE
SPECIFICATIONS

1. SCOPE OF SUPPLY -

Furnish and install TSURUMI, VANCS Model _____ Submersible Pump(s). Each unit shall be capable of delivering _____ GPM(_____m³/min) at _____ Feet (_____ m) TDH. The pump(s) shall be designed to pump waste water, sewage or effluent containing _____ inch (_____ mm) diameter solids without damage during operation. The pump(s) shall be designed so that the shaft power required (BHP)/(kW) shall not exceed the motor rated output throughout the entire operating range of the pump performance curve. The pump discharge size shall be _____ inch, (_____ mm).

2. MATERIALS OF CONSTRUCTION -

Construction of major parts of the pumping unit(s) including pump casing, impeller, motor head cover and intermediate brackets shall be manufactured from recyclable, application appropriate resins. The need for a protective coating shall not be required. All exposed fasteners shall be stainless steel and shall have stainless steel mating anchors integrally cast into the mating part. All units shall be furnished with a NPT discharge companion flange. Impellers shall be of the multi-vane, semi-vortex, solids handling design and shall be slip fit to the shaft. The motor shaft shall be machined to provide a positive drive of the impeller. The pump casing shall incorporate an air relief valve.

3. MECHANICAL SEAL -

All units shall be furnished with a dual inside mechanical shaft seal located completely out of the pumpage, running in a separate oil filled chamber. Units shall be fitted with a device that shall provide positive lubrication of top mechanical seal, (down to one third of the standard oil level). The device shall not consume any additional electrical power. Units shall have silicon carbide mechanical seal faces. Mechanical seal hardware shall be Stainless steel.

4. MOTOR -

The pump motor(s) shall be _____ Hp., _____ kW., _____ V., 60 Hz., _____ Phase and shall be NEMA MG-1, Design Type B equivalent. Motor(s) shall be rated at _____ full load amps. Motor(s) shall have a 1.15 service factor and shall be rated for 6 starts per hour. Motor(s) shall be air filled, copper wound, class E insulated with built in thermal protection. Motor shaft shall be 403 stainless steel and shall be supported by two permanently lubricated, high temperature ball bearings, with a B-10 life rating at best efficiency point of 60,000 hours. The bearings shall be single row, double shielded, C3, deep groove type ball bearings. Bearing seats shall be rolled carbon steel or aluminum die casting. Motor housing shall be 304 stainless steel.

5. POWER CABLE AND CABLE ENTRANCE -

The pump power cable shall be suitable for submersible pump applications. The cable entrance shall incorporate built in strain relief, a one piece, three way mechanical compression seal with a fatigue reducing cable boot. The cable entrance assembly shall contain an anti-wicking block to eliminate water incursion into the motor due to Capillary wicking should the power cable be accidentally damaged.